

1、Features:

- Emitting Color: Cold White
- Lens Type: Yellow Diffused
- Device Outline: 5.7×3.0×0.90 (unit:mm)
- RoHS compliant

2、Applications:

- Backlight for Mobile, Machine Vision, LCD Display
- Backlight in Dashboard and switch of Automotive
- Indoor Lighting

3、Outline Dimensions:

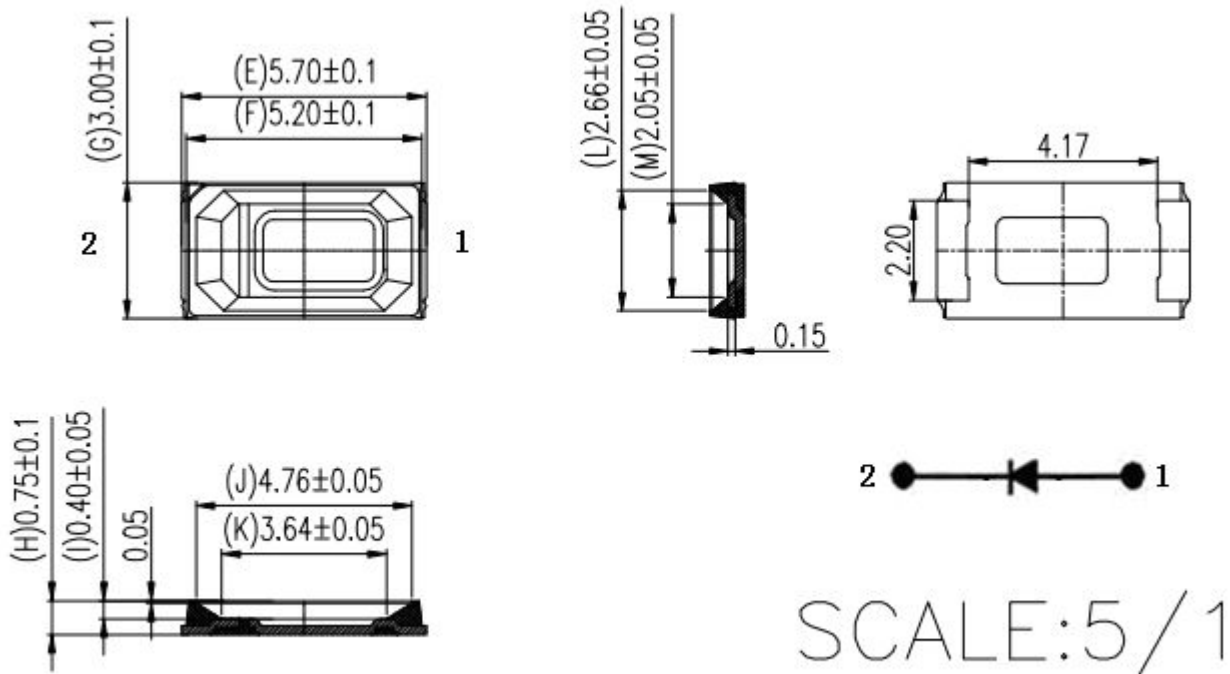

Note: 1.All dimension units are millimeters

2. All dimension tolerance is ±0.15mm



4、 Absolute maximum ratings (Ta = 25°C):

Parameter	Symbol	Test Condition	Value		Unit
			Min.	Max.	
Power Dissipation	Pd	—	—	500	mW
Reverse Voltage	VR	IR = 30 μA	5	—	V
Pulse Current	IFp	Duty=0.1, 1kHz	—	200	mA
Forward Current	IFm	—	—	150	mA
Operating Temperature	Topr	—	-40	+85	°C
Storage Temperature	Tstr	—	-40	+100	°C

5、 Electrical and optical characteristics (Ta = 25°C):

Parameter	Symbol	Test Condition	Value			Unit
			Min.	Typ.	Max.	
Forward Voltage	VF	IF = 150mA	3.0	—	3.5	V
Reverse Current	IR	VR = 5V	—	—	30	μA
Color Temperature	Tc	IF = 150mA	10000	—	15000	K
Luminous Flux	Iv	IF = 150mA	60	—	65	lm
Color Rendering index	Ra	IF = 150mA	80	—	—	—
Viewing Angle	2θ 1/2	IF = 150mA	—	120	—	Deg.

6、Typical electrical/optical characteristic curves/光电特性曲线:

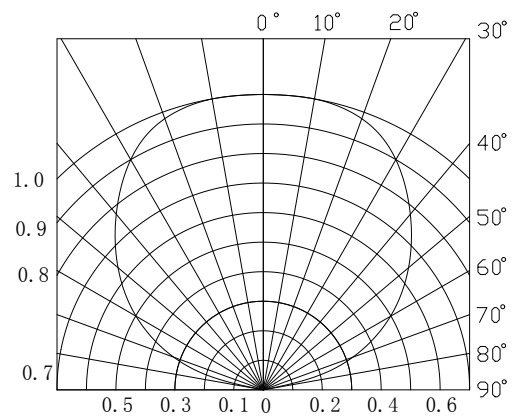
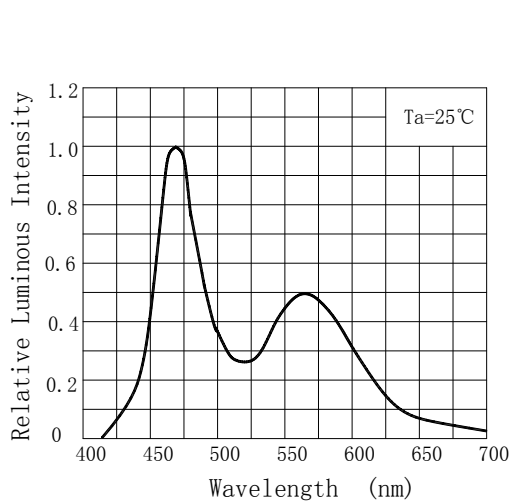
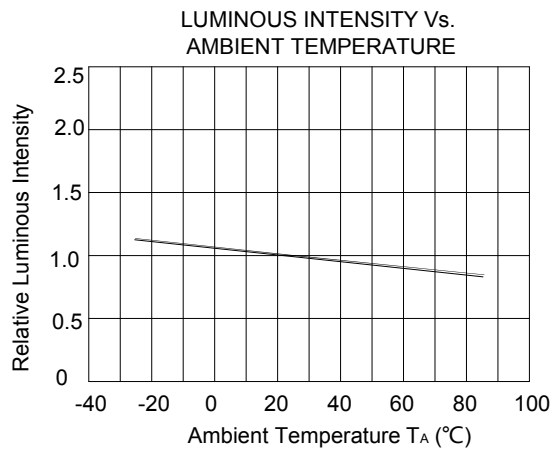
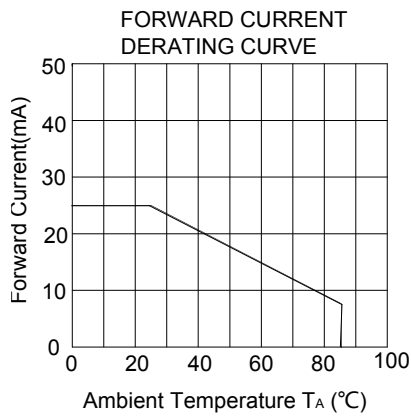
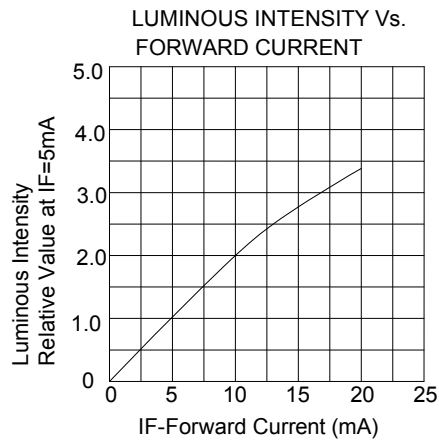
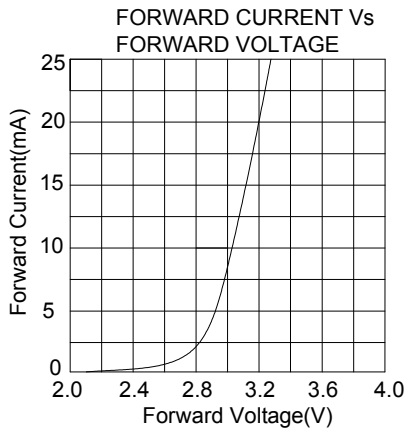



7、 Specification of Packing

7.1 Taping and Orientation

Quantity : 3500 units/reel

Diameter : 178 mm

