

1、 Features:

- Emitting Color: Warm White
- Lens Type: Yellow Diffused
- Device Outline: 3.0×1.4×0.8 (unit:mm)
- RoHS compliant

2、 Applications:

- Backlight for Mobile, Machine Vision, LCD Display
- Backlight in Dashboard and switch of Automotive

3、 Outline Dimensions:

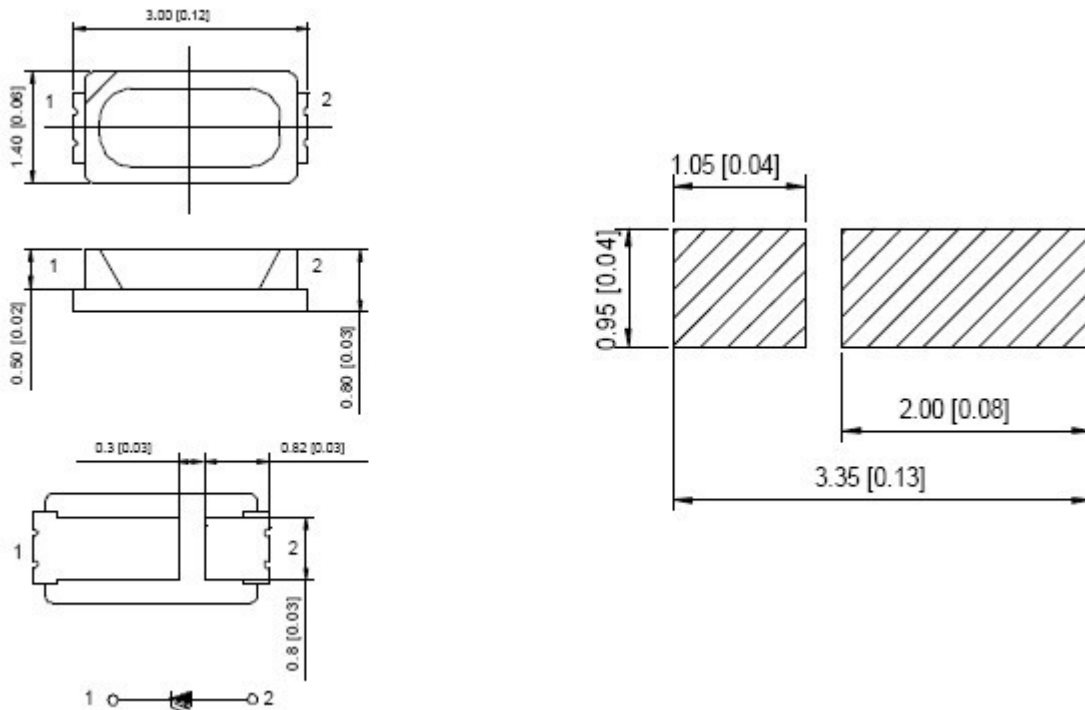

All dimensions in mm.

Tolerances unless mentioned is ± 0.1 mm

Part No.: JSL-3014WWC

4、 Absolute maximum ratings (Ta = 25°C):

Parameter	Symbol	Test Condition	Value		Unit
			Min.	Max.	
Power Dissipation	Pd	—	—	120	mW
Reverse Voltage	VR	IR = 30 μ A	5	—	V
Pulse Current	IFp	Duty=0.1, 1kHz	—	100	mA
Forward Current	IFm	—	—	35	mA
Operating Temperature	Topr	—	-40	+85	°C
Storage Temperature	Tstr	—	-40	+100	°C

5、 Electrical and optical characteristics (Ta = 25°C):

Parameter	Symbol	Test Condition	Value			Unit
			Min.	Typ.	Max.	
Forward Voltage	VF	IF = 30mA	3.0	—	3.6	V
Reverse Current	IR	VR = 5V	—	—	10	μ A
Color Temperature	Tc	IF = 30mA	—	3000	—	K
Luminous Intensity	Iv	IF = 30mA	2600	—	3600	mcd
Luminous Flux	Iv	IF = 30mA	10.0	11.0	12.0	lm
Color Rendering index	Ra	IF = 60mA	70	—	—	—
Viewing Angle	2 θ 1/2	IF = 30mA	—	120	—	Deg.

6、Typical electrical/optical characteristic curves/光电特性曲线:

Fig.1 正向电流 Vs. 正向电压

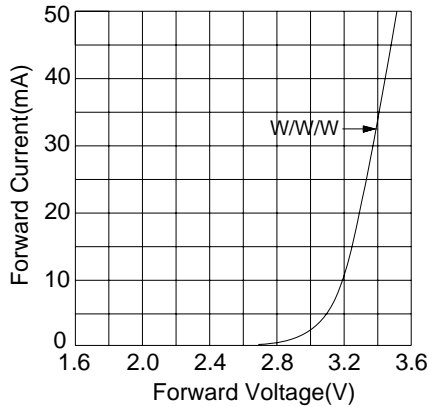

Fig.2 相对亮度 Vs. 正向电流

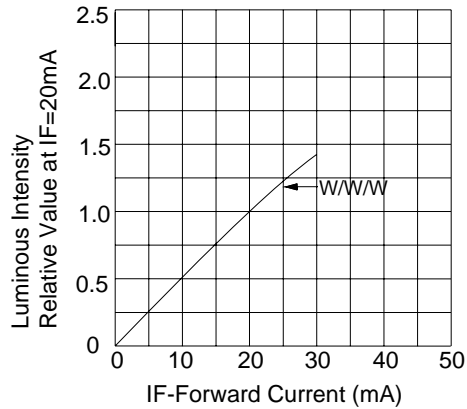

Fig.3 正向电流 Vs. 环境温度

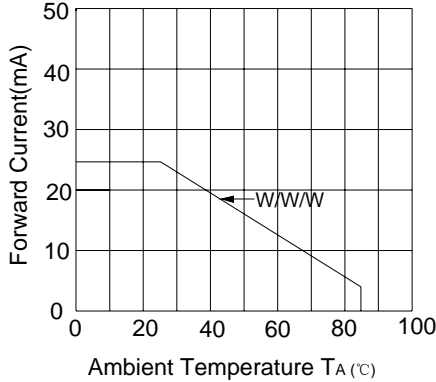
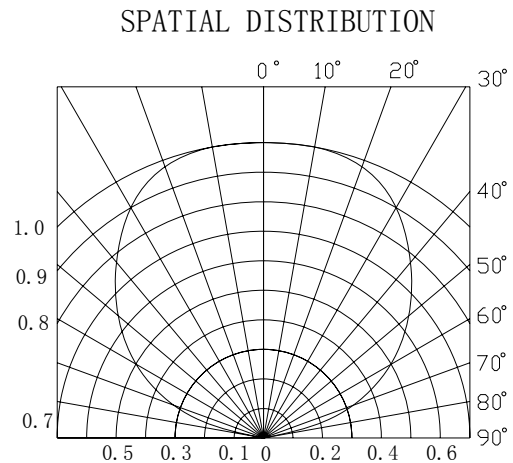
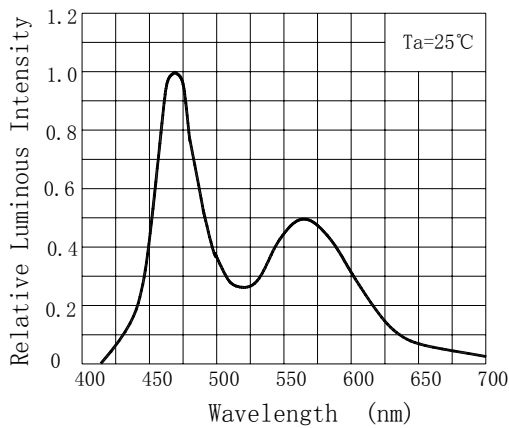
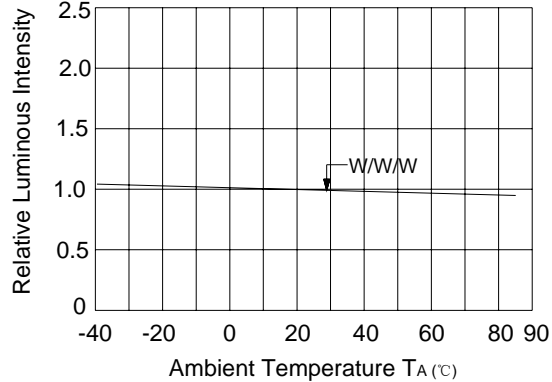

Fig.4 相对亮度 Vs. 环境温度





Ningbo Junsheng Electronics Co.,LTD.

Part No.: JSL-3014WWC

7、 Relibility Analysis

7.1 Test Items And Results

No.	Item	Test Condition	Spec.	Q'ty	Time	Standard
1	IR Reflow (Reflow Soldering)	Tsld=260°C, 10sec	GB/T 4937, II, 2.2	20	2times	ALL PASS
2	Solder ability	Tsld=235±5°C, 3sec		20	1times Over 95%	ALL PASS
3	Temperature Cycle/	-40°C—— 100°C 30min ~ 30min The cut is not more than 1 min	GB/T 4937, III, 1	20	50cycles	ALL PASS
4	Moisture Resistance Cyclic	25°C/12hr~ 55°C/12hr 95%RH	GB/T 4937, III, 4	20	6cycles	ALL PASS
5	High Temperature Storage	Ta=100°C	GB/T 4937, III, 2	20	1000hrs	ALL PASS
6	Low Temperature Storage	Ta=-40°C	GB/T 4937, III, 2	20	1000hrs	ALL PASS
7	Steady State perating Life	IF=20mA Ta=25°C	GB/T 18904.3 Part A	20	1000hrs	Iv decay <30%

7.2 Criteria For Judging Damage

Item	Symbol	Test conditions	Criteria for Judgement	
			Min.	Max.
Luminous Intensity	Iv	IF=20mA	Iv*0.7	/
Forward Voltage	VF	IF=20mA	/	U.S.L*1.1
Reverse current	IR	VR=5v	/	U.S.L*2

8、 Specification of Packing

8.1 Taping and Orientation

Quantity: 4000 units/reel

Diameter: 178 mm

