

1、 Features:

- Emitting Color: White
- Lens Type: Yellow Diffused
- Device Outline: 3.5×2.8×1.9 (unit:mm)
- RoHS compliant

2、 Applications:

- Backlight for Mobile, Machine Vision, LCD Display
- Backlight in Dashboard and switch of Automive

3、 Outline Dimensions:

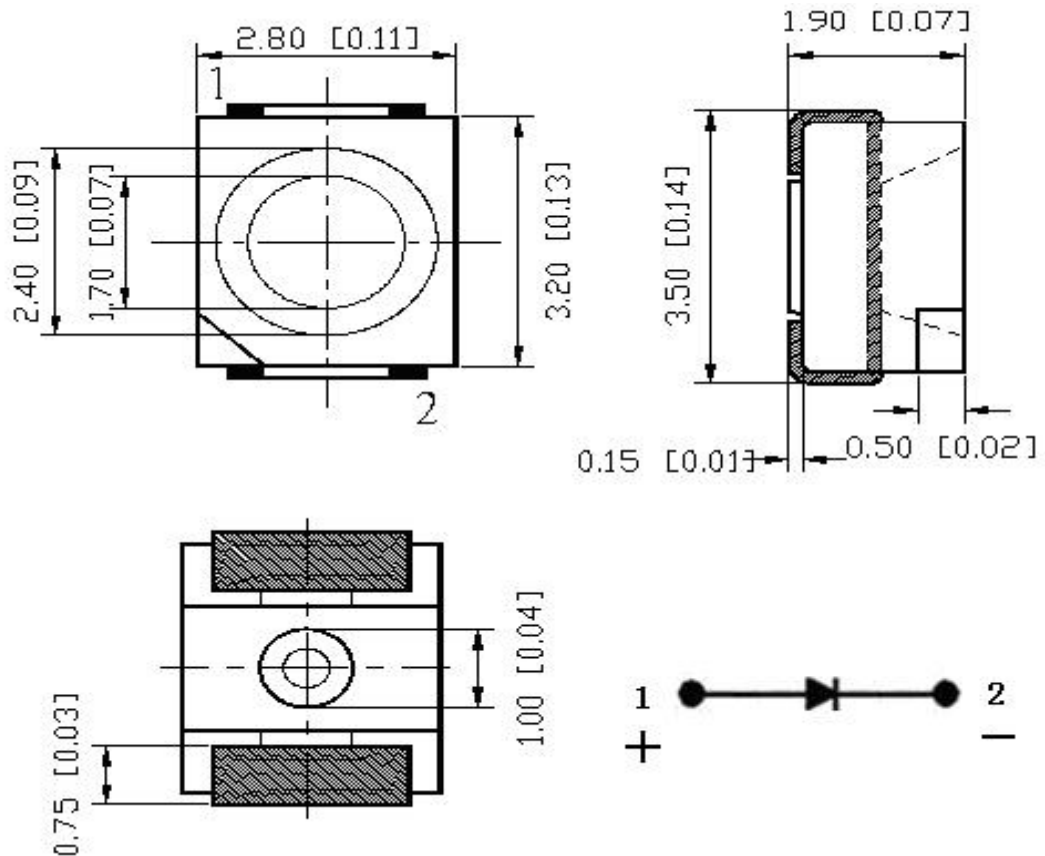



4、 Absolute maximum ratings (Ta = 25°C):

Parameter	Symbol	Test Condition	Value		Unit
			Min.	Max.	
Power Dissipation	Pd	---	---	100	mW
Reverse Voltage	VR	IR = 30 μ A	5	---	V
Pulse Current	IFp	Duty=0.1, 1kHz	---	100	mA
Forward Current	IFm	---	---	25	mA
Operating Temperature	Topr	---	-40	+85	°C
Storage Temperature	Tstr	---	-40	+100	°C

5、 Electrical and optical characteristics (Ta = 25°C):

Parameter	Symbol	Test Condition	Value			Unit
			Min.	Typ.	Max.	
Forward Voltage	VF	IF = 20mA	3.0	3.2	3.6	V
Reverse Current	IR	VR = 5V	---	---	30	μ A
Color Temperature	Tc	IF = 20mA	---	6000	---	K
Luminous Intensity	Iv	IF = 20mA	2000	2300	2600	mcd
Luminous Flux	Iv	IF = 20mA	6.0	7.0	8.0	lm
Viewing Angle	2 θ 1/2	IF = 20mA	---	120	---	Deg.

6、Typical electrical/optical characteristic curves/光电特性曲线:

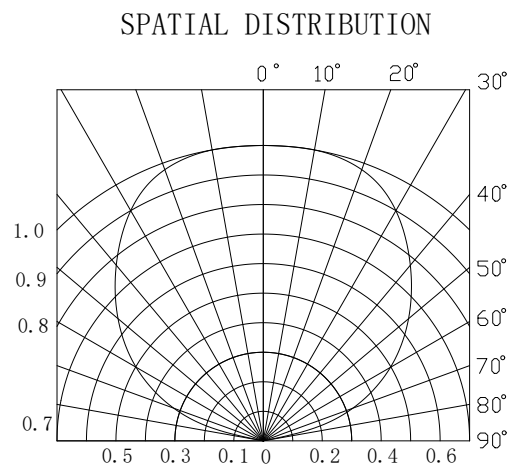
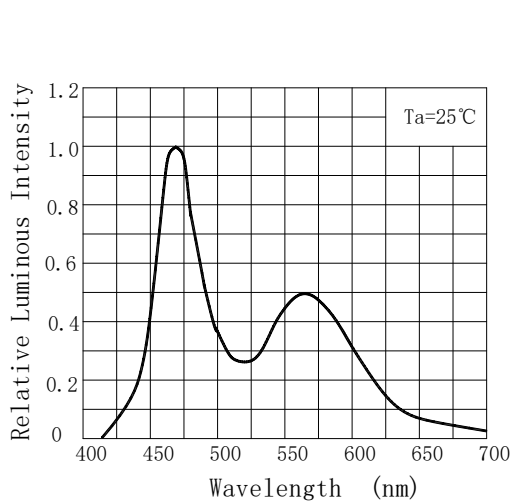
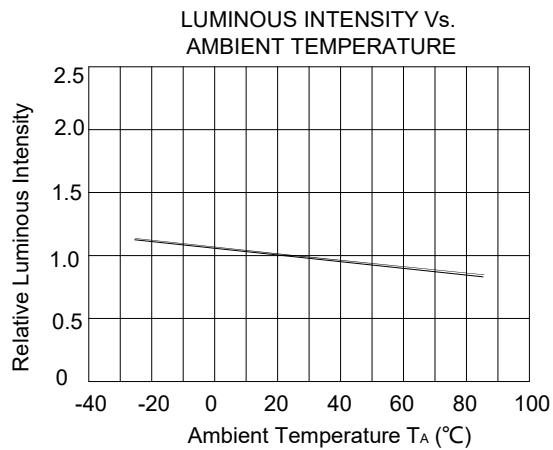
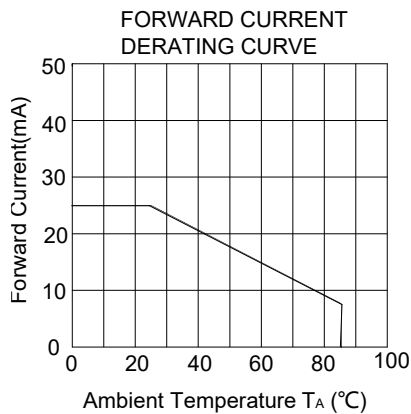
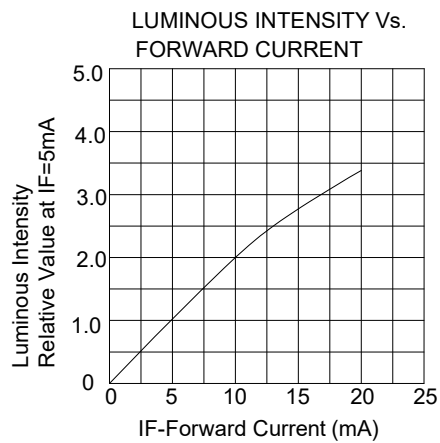
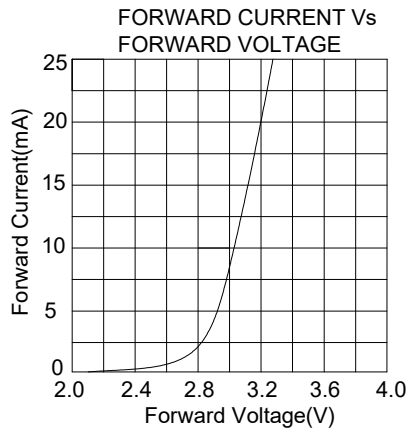



7、 Specification of Packing

8.1 Taping and Orientation

Quantity: 2000 units/reel

Diameter: 178 mm

