

Ningbo Junsheng Electronics Co.,Ltd.

0.30" (7.62mm) Dual Digit 7 Segment Display

Features:

- *Ultra segment intensity
- *Wide viewing angle
- *Range of colors
- *Gray face White segment
- *RoHS compliant

Available option:

- *Alternative face and segment color
- *Alternative font
- *Cropped terminal pins
- *Available emitting color
- *Low current version

Electro/Optical Characteristics $I_f=20mA$ $T_a=25^\circ C$

Part Number Common Cathode	Part Number Common Anode	Emitting Color	Peak Wavelength	Forward Voltage V_f		Luminous Intensity I_v	
				Typ.	Max.	Min.	Typ.
JS2-3021EUR-21	JS2-3021FUR-21	AlGaInP/GaAs Super Red	630	2.00	2.50	10.00	20.00
JS2-3021EUE-21	JS2-3021FUE-21	AlGaInP/GaAs Ultra Red	625	2.00	2.50	40.00	80.00
JS2-3021EUA-21	JS2-3021FUA-21	AlGaInP/GaAs Ultra Amber	605	2.00	2.50	40.00	60.00
JS2-3021EUY-21	JS2-3021FUY-21	AlGaInP/GaAs Ultra Yellow	590	2.00	2.50	40.00	60.00
JS2-3021EUG-21	JS2-3021FUG-21	AlGaInP/GaAs Yellow Green	574	2.10	2.50	10.00	15.00
JS2-3021EPG-21	JS2-3021FPG-21	InGaN/SiC Pure Green	525	3.30	3.80	150.00	200.00
JS2-3021EUB-21	JS2-3021FUB-21	InGaN/SiC Ultra Blue	470	3.30	3.80	40.00	50.00
JS2-3021EUW-21	JS2-3021FUW-21	InGaN/SiC Ultra White	X-0.31/Y-0.31	3.30	3.80	200.00	400.00
Units			nm	V		mcd	

Maximum Ratings $T_a=25^\circ C$ (Derate above $25^\circ C$)

Characteristic	Test Condition	Symbol	UR	UE	UA	UY	UG	PG	UB	UW	Units
Pulse Forward Current Per Seg.	1/10 duty cycle 0.1ms Pulse width	I_{FP}	100	100	100	100	100	100	100	100	mA
DC Forward Current Per Seg.		I_F	30	30	30	30	30	30	30	30	mA
Reverse Current Per Seg.	$V_R=5V$	I_R	10	10	10	10	10	10	10	10	μA
Power Dissipation		P_D	36	40	42	42	44	66	66	66	mW
Operating Temperature		T_{OPR}	-40 to +80								$^\circ C$
Storage Temperature		T_{TSG}	-40 to +85								$^\circ C$
Lead soldering temperature	1.60mm from body maximum 3 seconds		260								$^\circ C$

Checked	Becky Sun	Approved	Jason Lou	Date	Aug/14/2013	PAGE 1 / 2
---------	-----------	----------	-----------	------	-------------	------------

Ningbo Junsheng Electronics Co.,Ltd.

0.30" (7.62mm) Dual Digit 7 Segment Display

PACKAGE DIMENSION

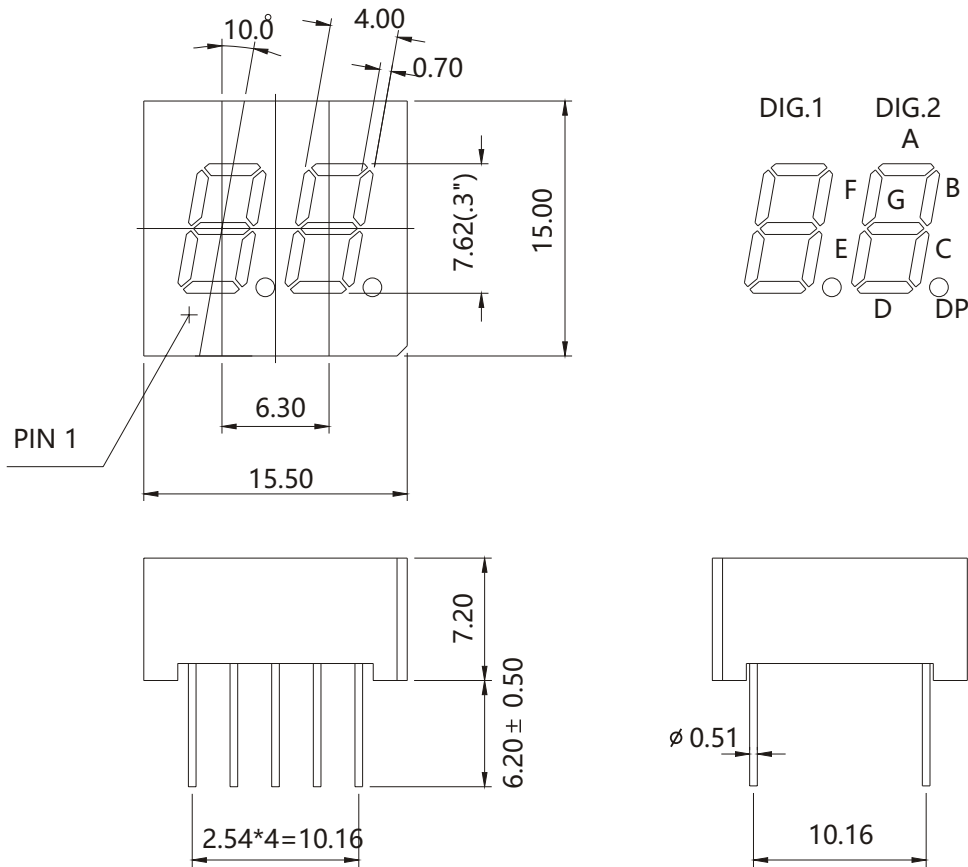

INTERNAL CIRCUIT DIAGRAM

Common Cathode JS2-3021Ex

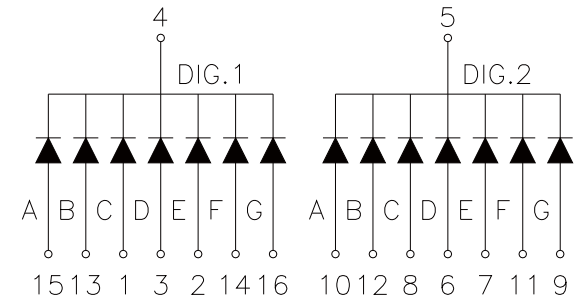

Common Anode JS2-3021Fx

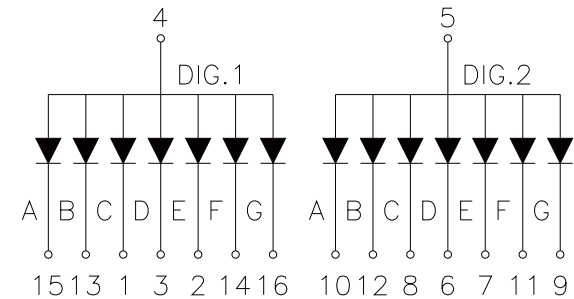

Tolerance $\pm 0.25\text{mm}$ unless stated