

# Ningbo Junsheng Electronics Co.,Ltd.

## 0.39" (10.0mm) Three Digit 7 Segment Display

### Features:

- \*Ultra segment intensity
- \*Wide viewing angle
- \*Range of colors
- \*Gray face White segment
- \*RoHS compliant

### Available option:

- \*Alternative face and segment color
- \*Alternative font
- \*Cropped terminal pins
- \*Available emitting color
- \*Low current version

### Electro/Optical Characteristics $I_f=20mA$ $T_a=25^\circ C$

Part Number Common Cathode	Part Number Common Anode	Emitting Color	Peak Wavelength	Forward Voltage $V_f$		Luminous Intensity $I_v$	
				Typ.	Max.	Min.	Typ.
JS3-3932AUR-21	JS3-3932BUR-21	AlGaInP/GaAs Super Red	630	2.00	2.50	10.00	20.00
JS3-3932AUE-21	JS3-3932BUE-21	AlGaInP/GaAs Ultra Red	625	2.00	2.50	40.00	80.00
JS3-3932AUA-21	JS3-3932BUA-21	AlGaInP/GaAs Ultra Amber	605	2.00	2.50	40.00	60.00
JS3-3932AUY-21	JS3-3932BUY-21	AlGaInP/GaAs Ultra Yellow	590	2.00	2.50	40.00	60.00
JS3-3932AUG-21	JS3-3932BUG-21	AlGaInP/GaAs Yellow Green	574	2.10	2.50	10.00	15.00
JS3-3932APG-21	JS3-3932BPG-21	InGaN/SiC Pure Green	525	3.30	3.80	150.00	200.00
JS3-3932AUB-21	JS3-3932BUB-21	InGaN/SiC Ultra Blue	470	3.30	3.80	40.00	50.00
JS3-3932AUW-21	JS3-3932BUW-21	InGaN/SiC Ultra White	X-0.31/Y-0.31	3.30	3.80	200.00	400.00
Units			nm	V		mcd	

### Maximum Ratings $T_a=25^\circ C$ (Derate above $25^\circ C$ )

Characteristic	Test Condition	Symbol	UR	UE	UA	UY	UG	PG	UB	UW	Units
Pulse Forward Current Per Seg.	1/10 duty cycle 0.1ms Pulse width	$I_{FP}$	100	100	100	100	100	100	100	100	mA
DC Forward Current Per Seg.		$I_F$	30	30	30	30	30	30	30	30	mA
Reverse Current Per Seg.	$V_R=5V$	$I_R$	10	10	10	10	10	10	10	10	$\mu A$
Power Dissipation		$P_D$	36	40	42	42	44	66	66	66	mW
Operating Temperature		$T_{OPR}$	-40 to +80								$^\circ C$
Storage Temperature		$T_{TSG}$	-40 to +85								$^\circ C$
Lead soldering temperature	1.60mm from body maximum 3 seconds		260								$^\circ C$

Checked	Becky Sun	Approved	Jason Lou	Date	Aug/14/2013	PAGE 1 / 2
---------	-----------	----------	-----------	------	-------------	------------

# Ningbo Junsheng Electronics Co.,Ltd.

## 0.39" (10.0mm) Three Digit 7 Segment Display

### PACKAGE DIMENSION

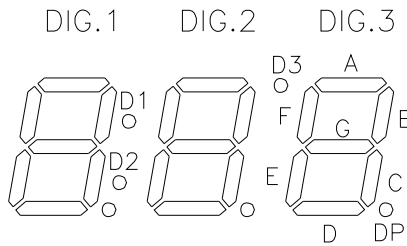
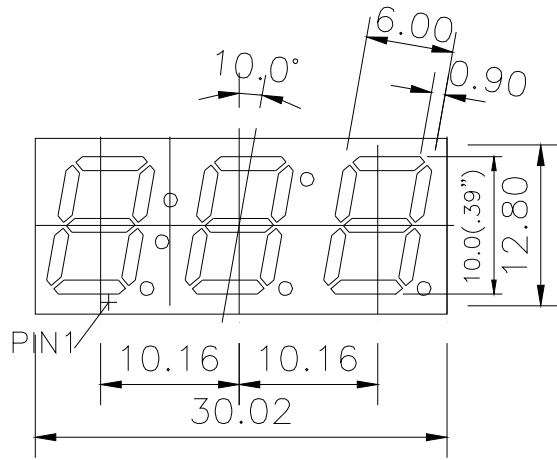

### INTERNAL CIRCUIT DIAGRAM

#### Common Cathode JS3-3932Ax

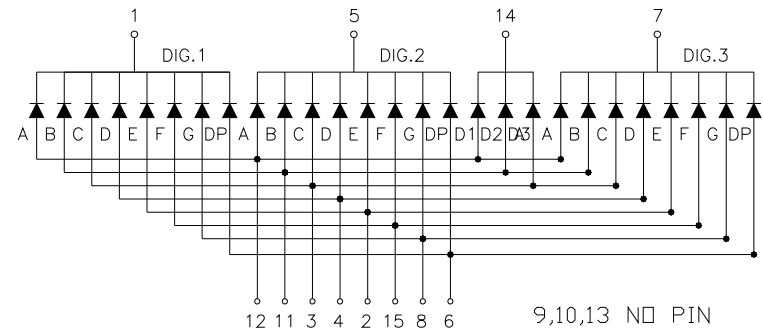

#### Common Anode JS3-3932Bx

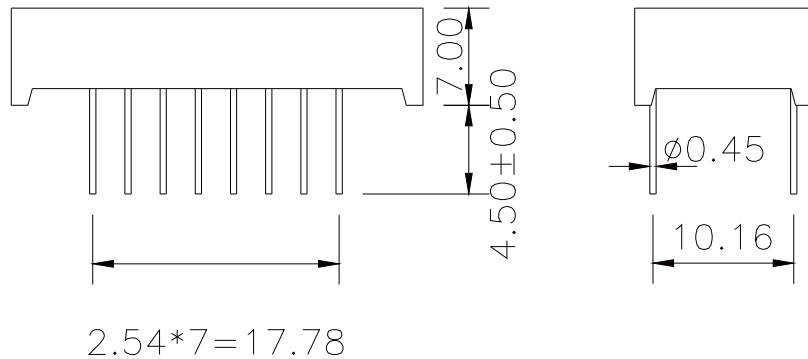
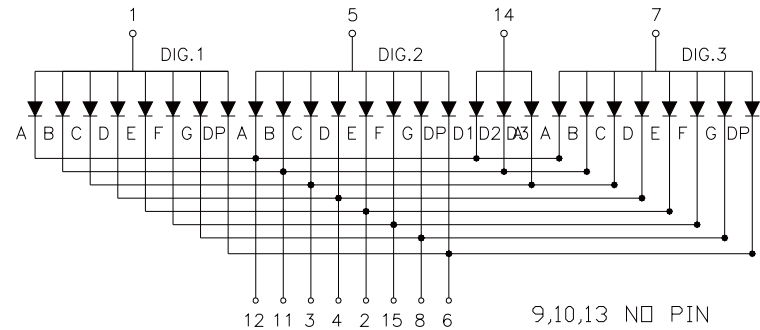

Tolerance  $\pm 0.25\text{mm}$  unless stated

Checked

Becky Sun

Approved

Jason Lou

Date

Aug/14/2013

PAGE 2 /2