

Ningbo Junsheng Electronics Co.,Ltd.

0.30"(7.62mm)Single Digit 7 Segment Display

Features:

- *Ultra segment intensity
- *Wide viewing angle
- *Range of colors
- *Gray face White segment
- *RoHS compliant

Available option:

- *Alternative face and segment color
- *Alternative font
- *Cropped terminal pins
- *Available emitting color
- *Low current version

Electro/Optical Characteristics If=20mA Ta=25°C

Part Number Common Cathode	Part Number Common Anode	Emitting Color	Peak Wavelength	Forward Voltage Vf		Luminous Intensity Iv	
				Typ.	Max.	Min.	Typ.
JS1-3014AUR-21	JS1-3014BUR-21	AlGaInP/GaAs Super Red	630	2.00	2.50	10.00	20.00
JS1-3014AUE-21	JS1-3014BUE-21	AlGaInP/GaAs Ultra Red	625	2.00	2.50	40.00	80.00
JS1-3014AUA-21	JS1-3014BUA-21	AlGaInP/GaAs Ultra Amber	605	2.00	2.50	40.00	60.00
JS1-3014AUY-21	JS1-3014BUY-21	AlGaInP/GaAs Ultra Yellow	590	2.00	2.50	40.00	60.00
JS1-3014AUG-21	JS1-3014BUG-21	AlGaInP/GaAs Yellow Green	574	2.10	2.50	10.00	15.00
JS1-3014APG-21	JS1-3014BPG-21	InGaN/SiC Pure Green	525	3.30	3.80	150.00	200.00
JS1-3014AUB-21	JS1-3014BUB-21	InGaN/SiC Ultra Blue	470	3.30	3.80	40.00	50.00
JS1-3014AUW-21	JS1-3014BUW-21	InGaN/SiC Ultra White	X-0.31/Y-0.31	3.30	3.80	200.00	400.00
Units			nm	V		mcd	

Maximum Ratings Ta=25°C (Derate above 25°C)

Characteristic	Test Condition	Symbol	UR	UE	UA	UY	UG	PG	UB	UW	Units
Pulse Forward Current Per Seg.	1/10 duty cycle 0.1ms Pulse width	I _{FP}	100	100	100	100	100	100	100	100	mA
DC Forward Current Per Seg.		I _F	30	30	30	30	30	30	30	30	mA
Reverse Current Per Seg.	V _R =5V	I _R	10	10	10	10	10	10	10	10	μA
Power Dissipation		P _D	36	40	42	42	44	66	66	66	mW
Operating Temperature		T _{OPR}	-40 to +80								°C
Storage Temperature		T _{TSG}	-40 to +85								°C
Lead soldering temperature	1.60mm from body maximum 3 seconds		260								°C

Checked

Becky Sun

Approved

Jason Lou

Date

Aug/14/2013

PAGE 1 /2

0.30"(7.62mm)Single Digit 7 Segment Display

PACKAGE DIMENSION

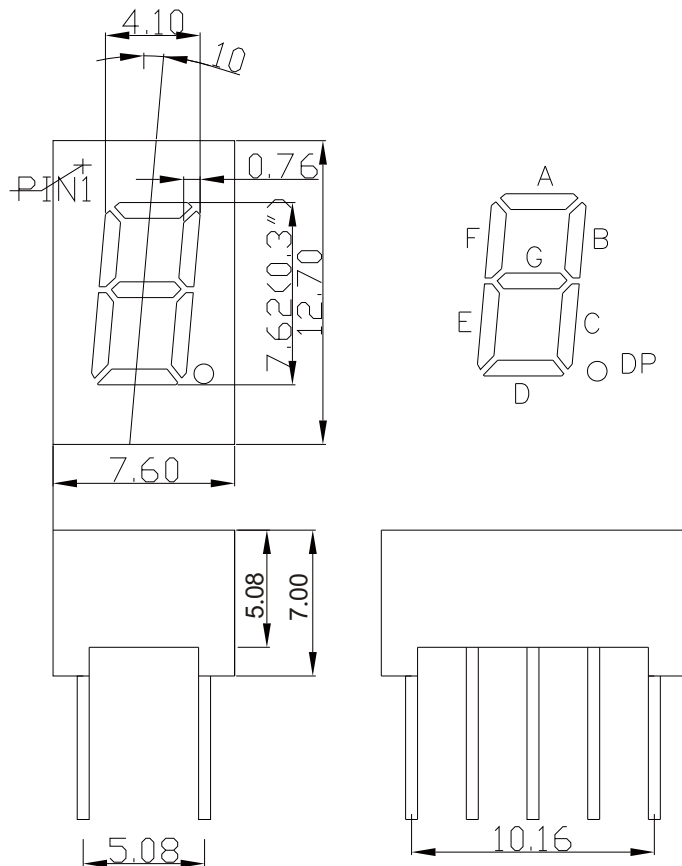

INTERNAL CIRCUIT DIAGRAM

Common Cathode
JS1-3014Ax

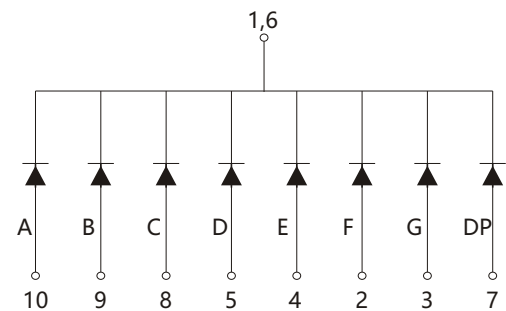

Common Anode
JS1-3014Bx

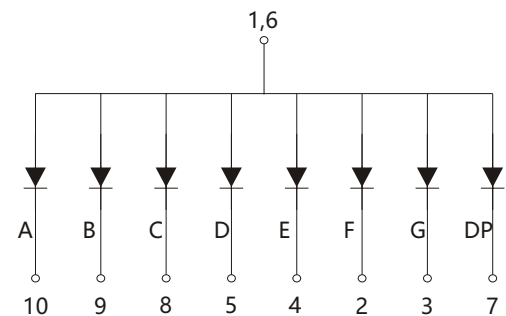

Tolerance $\pm 0.25\text{mm}$ unless stated

Checked	Becky Sun	Approved	Jason Lou	Date	Aug/14/2013	PAGE 2 /2
---------	-----------	----------	-----------	------	-------------	-----------