

Ningbo Junsheng Electronics Co.,Ltd.

1.50"(38.10mm)Single Digit 7 Segment Display

Features:

- *Ultra segment intensity
- *Wide viewing angle
- *Range of colors
- *Gray face White segment
- *RoHS compliant

Available option:

- *Alternative face and segment color
- *Alternative font
- *Cropped terminal pins
- *Available emitting color
- *Low current version

Electro/Optical Characteristics If=20mA Ta=25°C

Part Number Common Cathode	Part Number Common Anode	Emitting Color	Peak Wavelength	Forward Voltage V _F		Luminous Intensity I _v	
				Typ.	Max.	Min.	Typ.
JS1-15013AUR-21	JS1-15013BUR-21	AlGaInP/GaAs Super Red	630	2.00	2.50	20.00	40.00
JS1-15013AUE-21	JS1-15013BUE-21	AlGaInP/GaAs Ultra Red	625	2.00	2.50	80.00	160.00
JS1-15013AUA-21	JS1-15013BUA-21	AlGaInP/GaAs Ultra Amber	605	2.00	2.50	80.00	120.00
JS1-15013AUY-21	JS1-15013BUY-21	AlGaInP/GaAs Ultra Yellow	590	2.00	2.50	80.00	120.00
JS1-15013AUG-21	JS1-15013BUG-21	AlGaInP/GaAs Yellow Green	574	2.10	2.50	20.00	30.00
JS1-15013APG-21	JS1-15013BPG-21	InGaN/SiC Pure Green	525	3.30	3.80	300.00	400.00
JS1-15013AUB-21	JS1-15013BUB-21	InGaN/SiC Ultra Blue	470	3.30	3.80	80.00	100.00
JS1-15013AUW-21	JS1-15013BUW-21	InGaN/SiC Ultra White	X-0.31/Y-0.31	3.30	3.80	400.00	800.00
Units			nm	V		mcd	

Maximum Ratings Ta=25°C (Derate above 25°C)

Characteristic	Test Condition	Symbol	UR	UE	UA	UY	UG	PG	UB	UW	Units
Pulse Forward Current Per Seg.	1/10 duty cycle 0.1ms Pulse width	I _{FP}	100	100	100	100	100	100	100	100	mA
DC Forward Current Per Seg.		I _F	30	30	30	30	30	30	30	30	mA
Reverse Current Per Seg.	V _R =5V	I _R	10	10	10	10	10	10	10	10	μA
Power Dissipation		P _D	36	40	42	42	44	66	66	66	mW
Operating Temperature		T _{OPR}	-40 to +80								°C
Storage Temperature		T _{TSG}	-40 to +85								°C
Lead soldering temperature	1.60mm from body maximum 3 seconds		260								°C

Checked	Becky Sun	Approved	Jason Lou	Date	Aug/14/2013	PAGE 1 / 2
---------	-----------	----------	-----------	------	-------------	------------

1.50"(38.10mm)Single Digit 7 Segment Display

PACKAGE DIMENSION

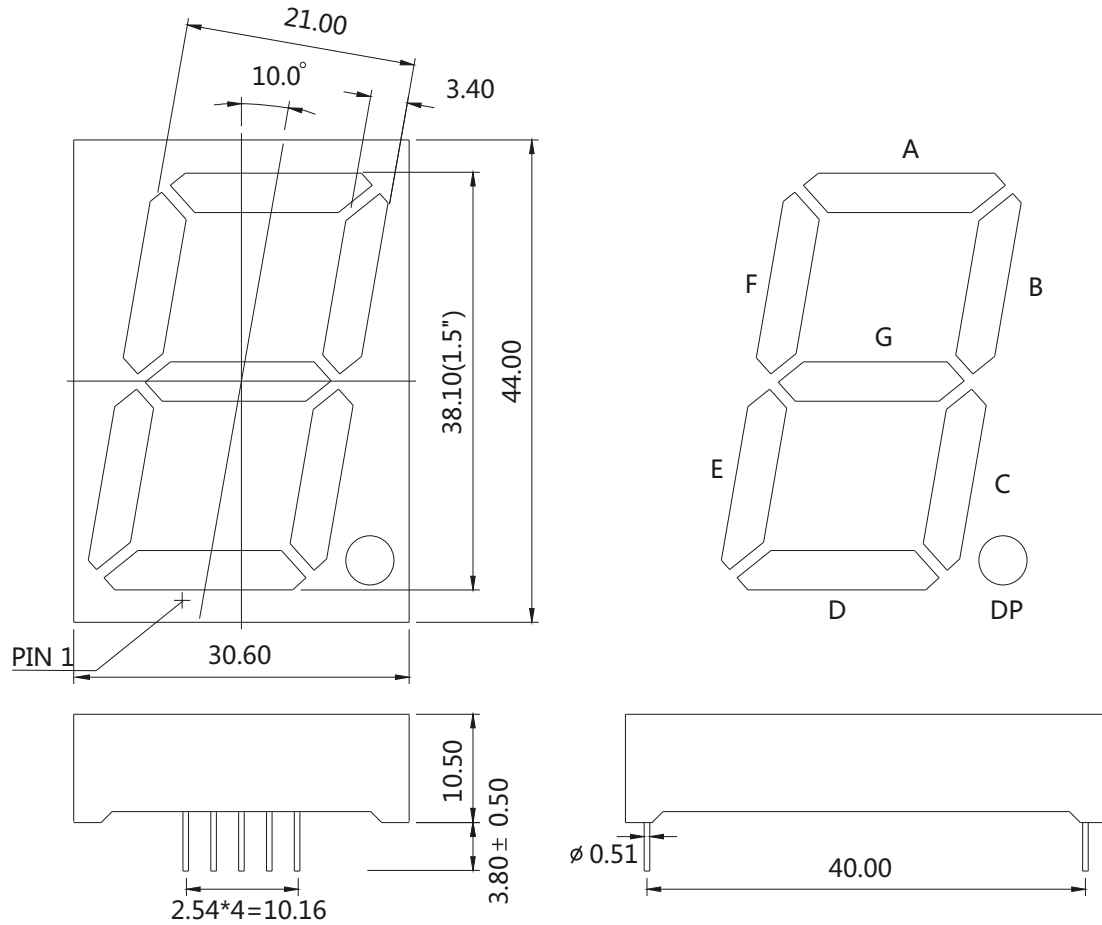

Tolerance $\pm 0.25\text{mm}$ unless stated

INTERNAL CIRCUIT DIAGRAM

Common Cathode
JS1-15013Ax

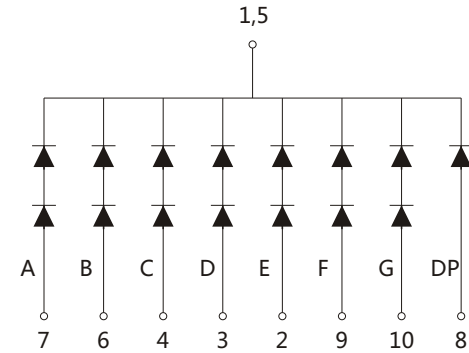

Common Anode
JS1-15013Bx

