



Part No.: JSL-1804URD

Features:

- Single color
- High bright output
- Low power consumption
- High reliability and long life

Descriptions:

- Emitting Color: Super Bright Red
- Device Outline: ϕ 1.8mm Round Type
- Lens Type: Red diffused
- The LED lamps are available with different colors, intensities.

Application:

- Circuit board.
- Indicators.
- Computer.
- Commercial use.



Part No.: JSL-1804URD

Package Dimension:

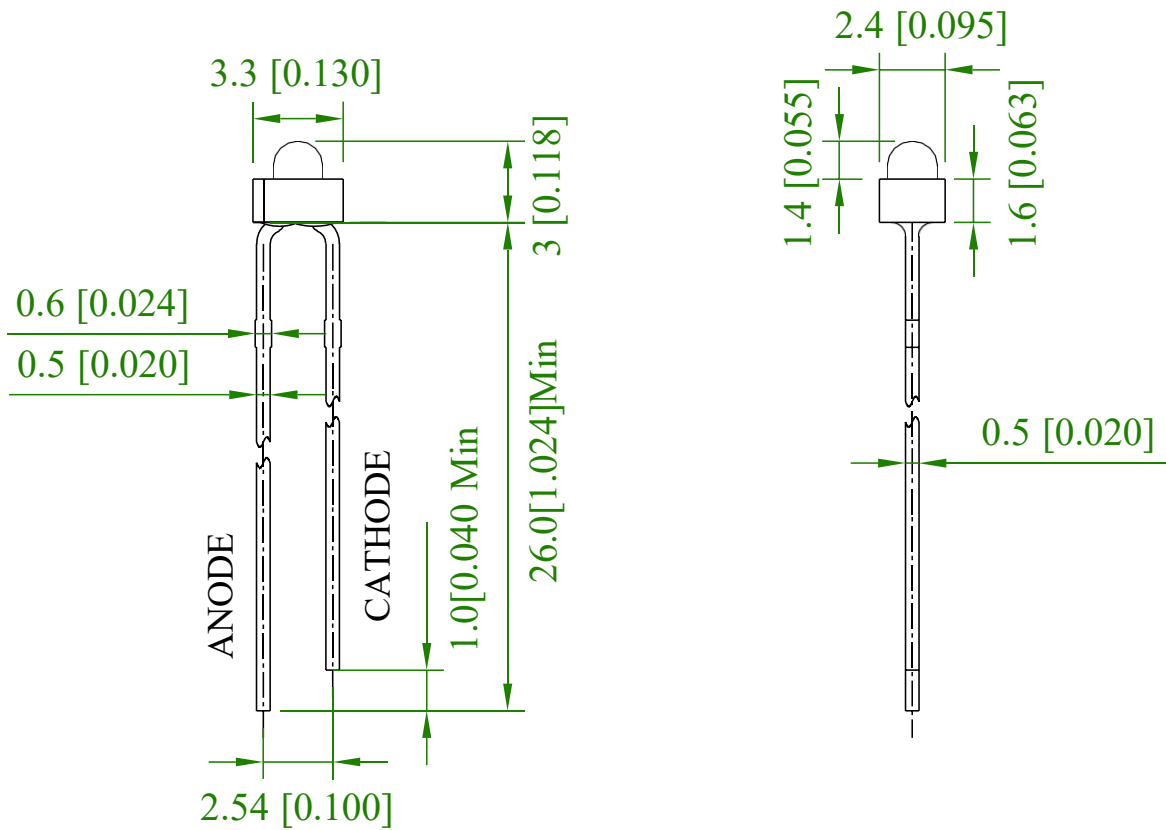
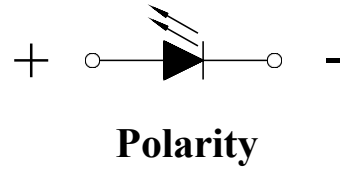
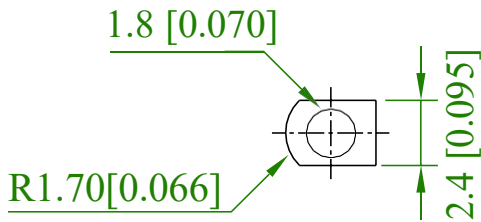

Notes:

1. All dimensions are millimeters/单位: mm.
2. Tolerance is +/-0.25mm unless otherwise noted/
没有标注的公差均为±0.25mm



Part No.: JSL-1804URD

Absolute maximum ratings (Ta = 25°C)

Parameter	Symbol	Test Condition	Values		Unit
			Min.	Max.	
Reverse Voltage	V _R	I _R = 30 μ A	----	5	V
Forward Current	I _F	----	----	25	mA
Power Dissipation	P _d	----	----	60	mW
Pulse Current	I _{peak}	Duty=0.1mS, 1kHz	----	100	mA
Operating Temperature	T _{opr}	----	-40	+85	°C
Storage Temperature	T _{str}	----	-40	+85	°C

Electrical and optical characteristics (Ta = 25°C)

Parameter	Symbol	Test Condition	Values			Unit
			Min.	Typ.	Max.	
Forward Voltage	V _F	I _F =20mA	1.8	2.0	2.4	V
Reverse Current	I _R	V _R =5V	----	----	30	μ A
Dominate Wavelength	λ _d	I _F =20mA	----	624	----	nm
Peak Wavelength	λ _p	I _F =20mA	----	632	----	nm
Spectral Line half-width	Δ λ	I _F =20mA	----	20	----	nm
Luminous Intensity	I _v	I _F =20mA	300	500	----	mcd
Viewing Angle	2 θ 1/2	I _F =20mA	----	60	----	deg.

Typical electrical/optical characteristic curves:

Fig.1

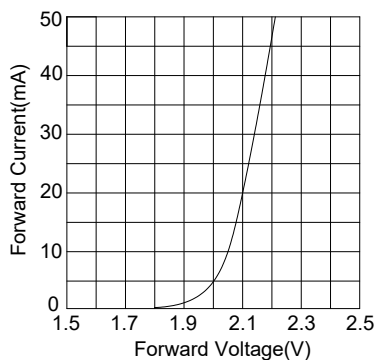

Fig.2

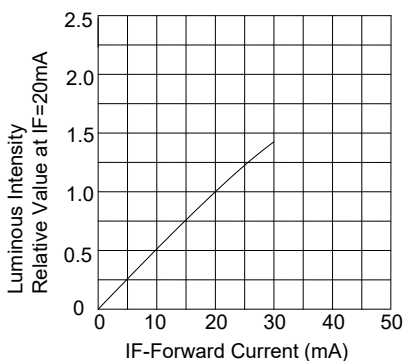

Fig.3

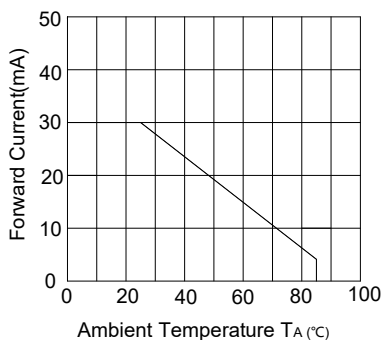

Fig.4

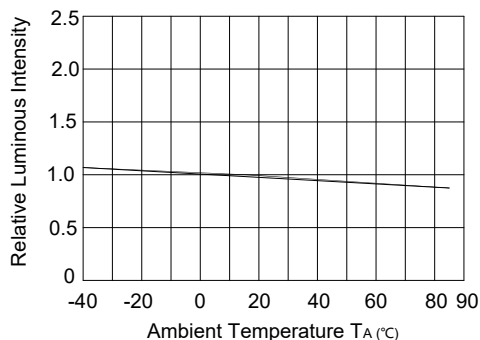

Fig.5

