



Part No.: JSL-1804UYC

Features:

- Single color
- High bright output
- Low power consumption
- High reliability and long life

Descriptions:

- Emitting Color: Super Bright Yellow
- Device Outline: ϕ 1.8mm Round Type
- Lens Type: Water Clear
- The LED lamps are available with different colors, intensities.

Application:

- Circuit board.
- Indicators.
- Computer.
- Commercial Lighting use.



Part No.: JSL-1804UYC

Package Dimension:

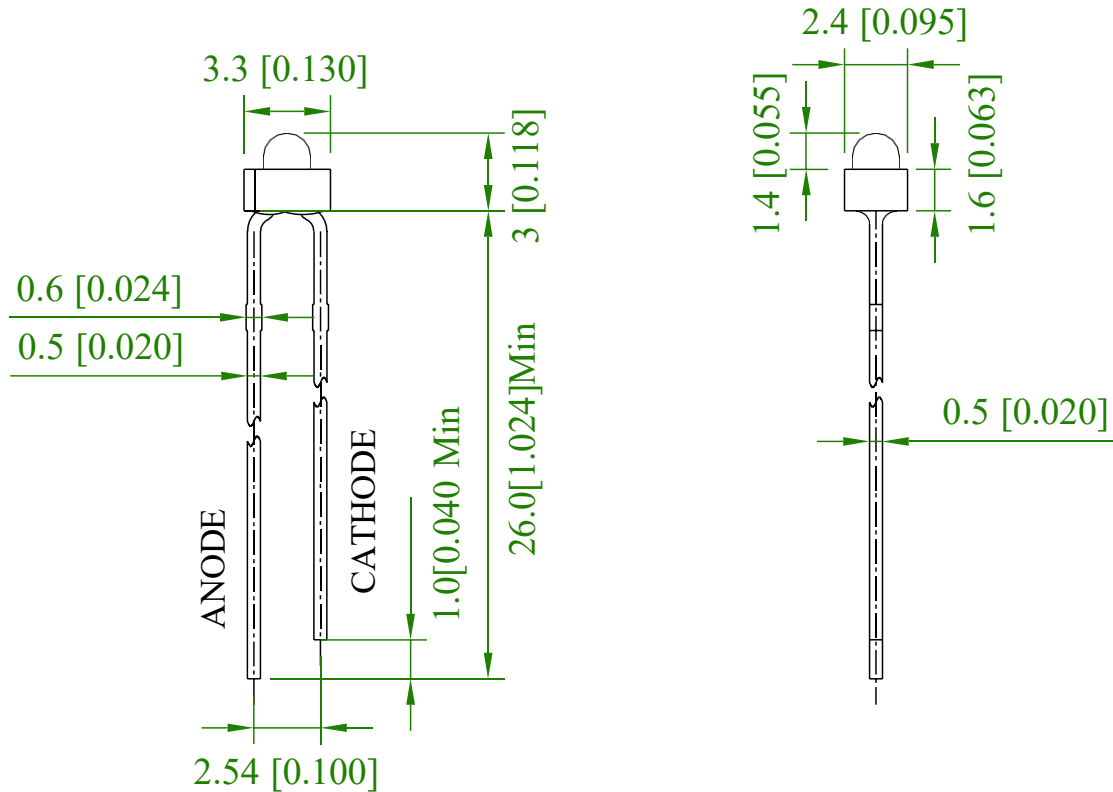
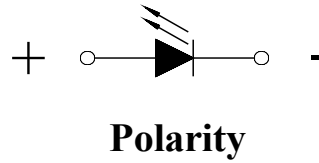
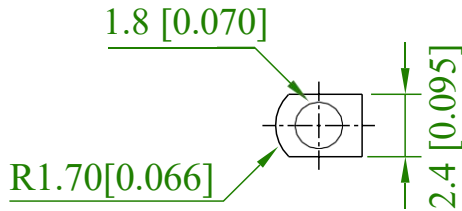

Notes:

1. All dimensions are millimeters/单位: mm.
2. Tolerance is +/-0.25mm unless otherwise noted/
没有标注的公差均为±0.25mm



Part No.: JSL-1804UYC

Absolute maximum ratings (Ta = 25°C)

| Parameter | Symbol | Test Condition | Values | | Unit |
|-----------------------|-------------------|-------------------------|--------|------|------|
| | | | Min. | Max. | |
| Reverse Voltage | V _R | I _R = 30 μ A | ---- | 5 | V |
| Forward Current | I _F | ---- | ---- | 25 | mA |
| Power Dissipation | P _d | ---- | ---- | 60 | mW |
| Pulse Current | I _{peak} | Duty=0.1mS, 1kHz | ---- | 100 | mA |
| Operating Temperature | T _{opr} | ---- | -40 | +85 | °C |
| Storage Temperature | T _{str} | ---- | -40 | +85 | °C |

Electrical and optical characteristics (Ta = 25°C)

| Parameter | Symbol | Test Condition | Values | | | Unit |
|--------------------------|----------------|----------------------|--------|------|------|------|
| | | | Min. | Typ. | Max. | |
| Forward Voltage | V _F | I _F =20mA | 1.8 | 2.0 | 2.4 | V |
| Reverse Current | I _R | V _R =5V | ---- | ---- | 30 | μ A |
| Dominate Wavelength | λ _d | I _F =20mA | ---- | 590 | ---- | nm |
| Peak Wavelength | λ _p | I _F =20mA | ---- | 592 | ---- | nm |
| Spectral Line half-width | Δ λ | I _F =20mA | ---- | 20 | ---- | nm |
| Luminous Intensity | I _v | I _F =20mA | 800 | 1000 | ---- | mcd |
| Viewing Angle | 2 θ 1/2 | I _F =20mA | ---- | 30 | ---- | deg. |

Typical electrical/optical characteristic curves:

Fig.1 正向电流 Vs. 正向电压

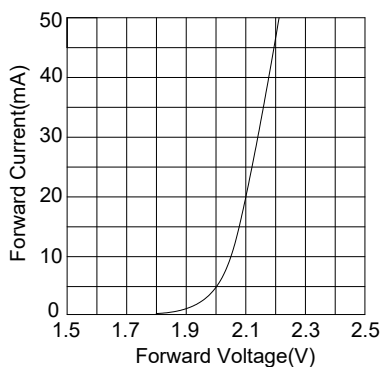

Fig.2 相对亮度 Vs. 正向电流

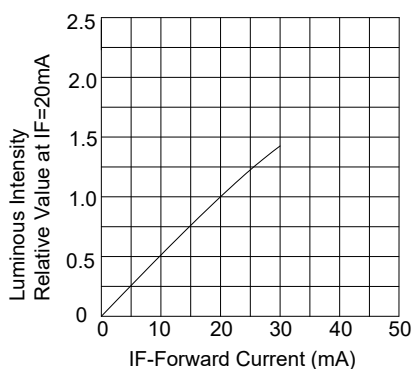

Fig.3 正向电流 Vs. 环境温度

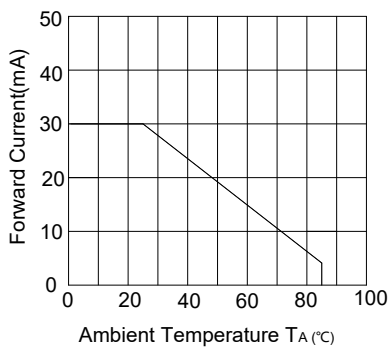

Fig.4 相对亮度 Vs. 环境温度

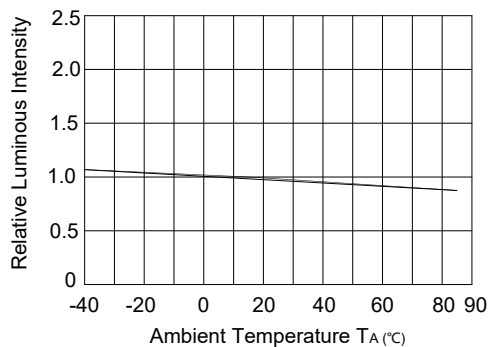

Fig.5 相对亮度 Vs. 波长

