



Part No.: JSL-1804UBC

Features:

- Single color
- High bright output
- Low power consumption
- High reliability and long life

Descriptions:

- Emitting Color: Super Bright Blue
- Device Outline: ϕ 1.8mm Round Type
- Lens Type: Water Clear
- The LED lamps are available with different colors, intensities.

Application:

- Circuit board.
- Indicators.
- Computer.
- Commercial Lighting use.



Part No.: JSL-1804UBC

Package Dimension:

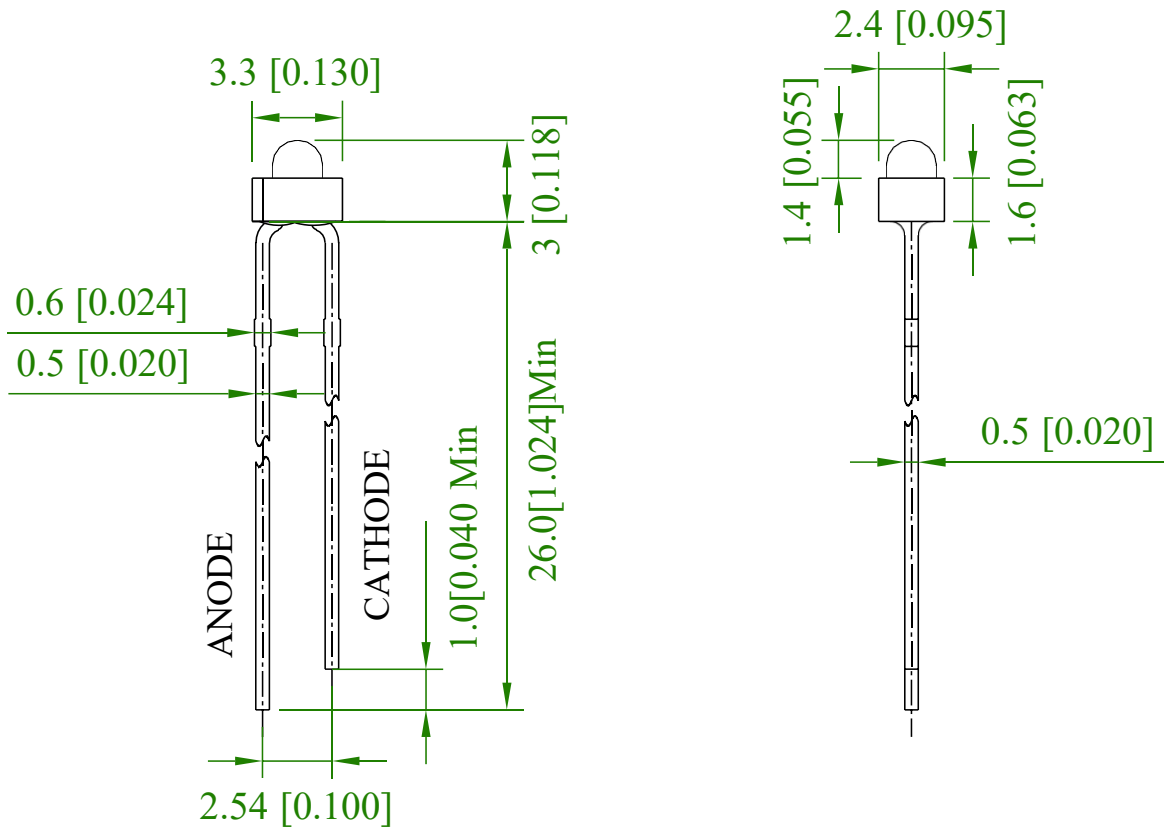
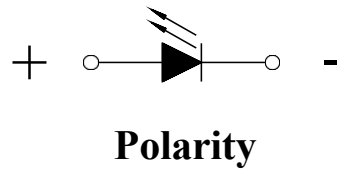
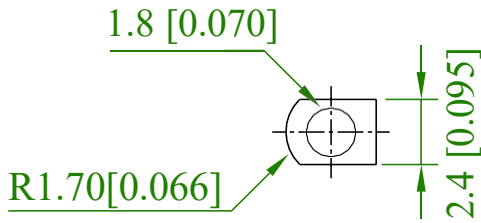

Notes:

1. All dimensions are millimeters/单位: mm.
2. Tolerance is +/-0.25mm unless otherwise noted/
没有标注的公差均为±0.25mm



Part No.: JSL-1804UBC

Absolute maximum ratings (Ta = 25°C)

Parameter	Symbol	Test Condition	Values		Unit
			Min.	Max.	
Reverse Voltage	V _R	I _R = 30 μ A	----	5	V
Forward Current	I _F	----	----	25	mA
Power Dissipation	P _d	----	----	85	mW
Pulse Current	I _{peak}	Duty=0.1mS, 1kHz	----	100	mA
Operating Temperature	T _{opr}	----	-40	+85	°C
Storage Temperature	T _{str}	----	-40	+85	°C

Electrical and optical characteristics (Ta = 25°C)

Parameter	Symbol	Test Condition	Values			Unit
			Min.	Typ.	Max.	
Forward Voltage	V _F	I _F =20mA	2.7	3.0	3.4	V
Reverse Current	I _R	V _R =5V	----	----	30	μ A
Dominate Wavelength	λ _d	I _F =20mA	----	470	----	nm
Peak Wavelength	λ _p	I _F =20mA	----	468	----	nm
Spectral Line half-width	Δ λ	I _F =20mA	----	25	----	nm
Luminous Intensity	I _v	I _F =20mA	800	1000	----	mcd
Viewing Angle	2 θ 1/2	I _F =20mA	----	30	----	deg.



Typical electrical/optical characteristic curves:

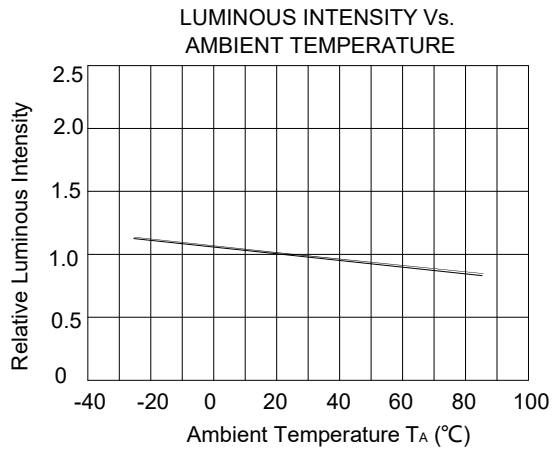
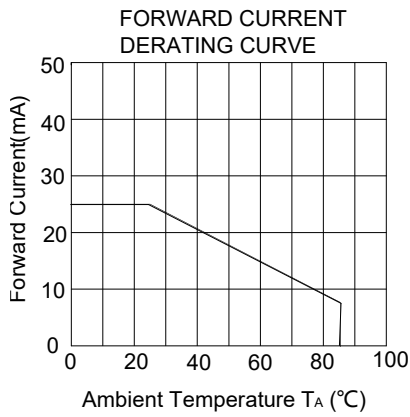
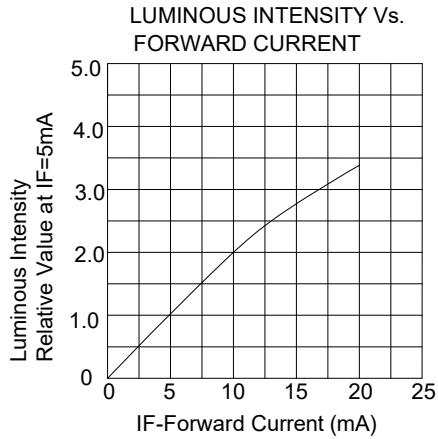
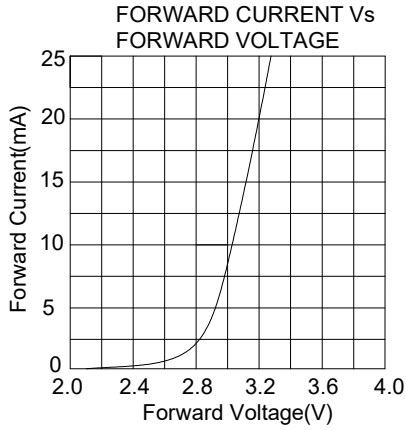

Fig.5 相对亮度 Vs. 波长

