



# Ningbo Junsheng Electronics Co.,LTD.

Part No.: JSL-522URUBC

## Features:

- Long life solid state reliability.
- Low power consumption
- I.C.compatible.
- Compliance with EU REACH.
- RoHs Compliant

## Descriptions:

- Emitting Color: Red+Blue Bi-Color.
- Device Outline:  $\phi$  5mm Round Type.
- Lens Type: Water Clear.
- The lamp contain two chips and is available as both bicolor and bipolar types.
- The designed for avariety of applications where require dual illumination.

## Application:

- Circuit board.
- Indicators.
- Computer.
- Home appliance.
- Industrial.



Part No.: JSL-522URUBC

Package Dimension:

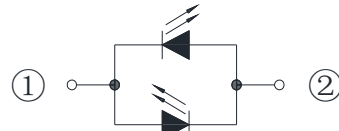
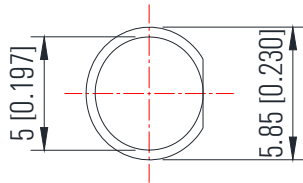

1 Anode the First Color,  
Cathode the Second Color  
2 Anode the Second Color,  
Cathode the First Color

Polarity

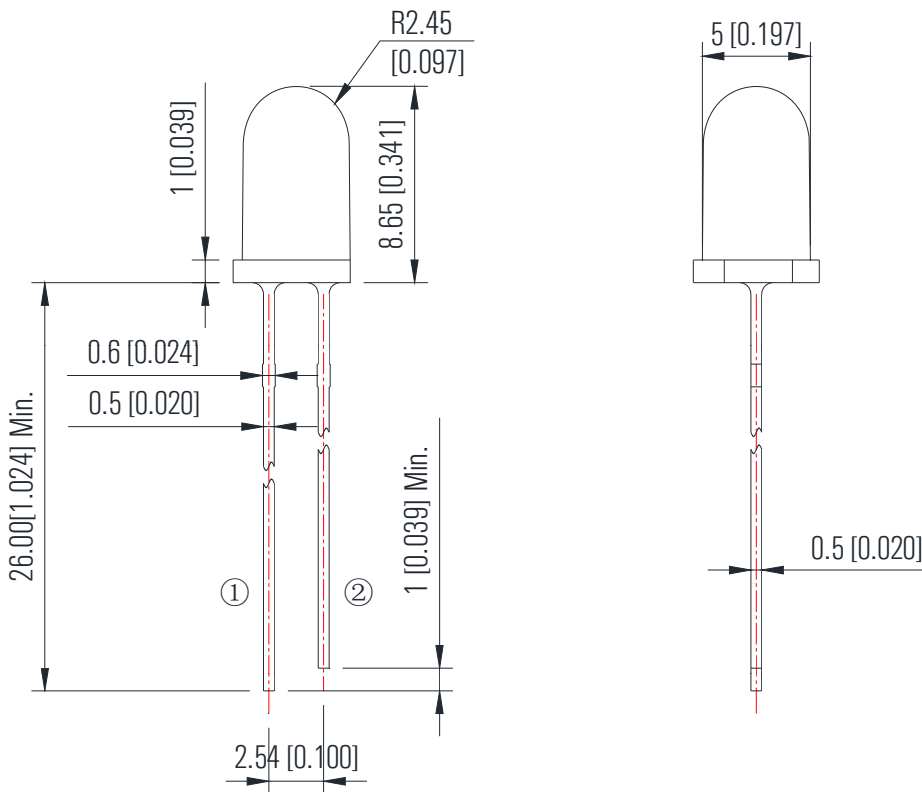

Notes:

1. All dimensions are millimeters/单位: mm.
2. Tolerance is +/-0.25mm unless otherwise noted/  
没有标注的公差均为±0.25mm



**Absolute maximum ratings (Ta = 25°C)**

Parameter	Symbol	Test Condition	Values		Unit
			Min.	Max.	
Reverse Voltage	V <sub>R</sub>	I <sub>R</sub> = 30 μA	----	5	V
Forward Current	I <sub>F</sub>	----	----	25	mA
Power Dissipation	P <sub>d</sub>	----	Red	60	mW
			Blue	85	
Pulse Current	I <sub>peak</sub>	Duty=0.1mS, 1kHz	----	100	mA
Operating Temperature	T <sub>opr</sub>	----	-40	+85	°C
Storage Temperature	T <sub>str</sub>	----	-40	+85	°C

**Electrical and optical characteristics (Ta = 25°C)**

Parameter	Symbol	Test Condition	Color	Value			Unit
				Min.	Typ.	Max.	
Forward Voltage	V <sub>F</sub>	I <sub>F</sub> = 20mA	UR	1.8	2.0	2.2	V
			UB	2.7	3.0	3.2	
Reverse Current	I <sub>R</sub>	V <sub>R</sub> = 5V	UR	---	---	5	μA
			UB	---	---	5	
Dominate Wavelength	λ <sub>d</sub>	I <sub>F</sub> = 20mA	UR	---	624	---	nm
			UB	---	470	---	
Peak Wavelength	λ <sub>p</sub>	I <sub>F</sub> = 20mA	UR	---	632	---	nm
			UB	---	468	---	
Spectral Line half-width	Δλ	I <sub>F</sub> =20mA	UR	----	20	----	nm
			UB	----	20	----	
Luminous Intensity	I <sub>v</sub>	I <sub>F</sub> = 20mA	UR	600	1000	----	mcd
			UB	1000	2000	----	
Viewing Angle	2θ 1/2	I <sub>F</sub> = 20mA	UR	---	30	---	deg
			UB	---	30	---	



### Typical electrical/optical characteristic curves:

(25°C Ambient Temperature Unless Otherwise Noted)

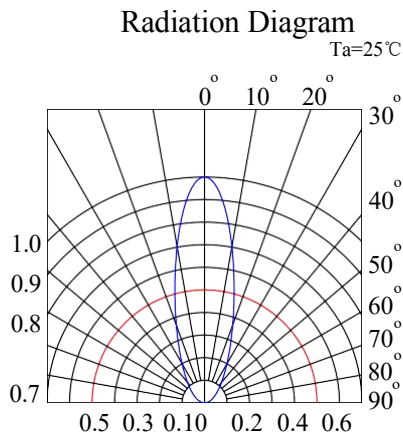
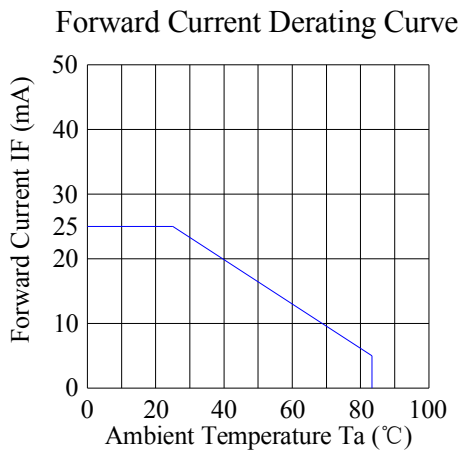
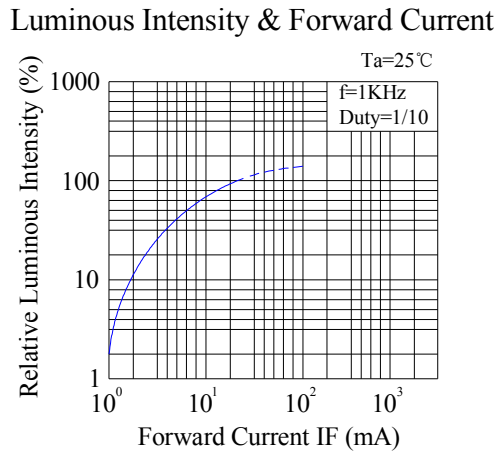
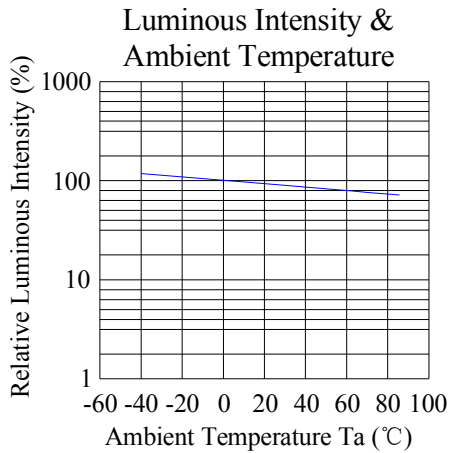
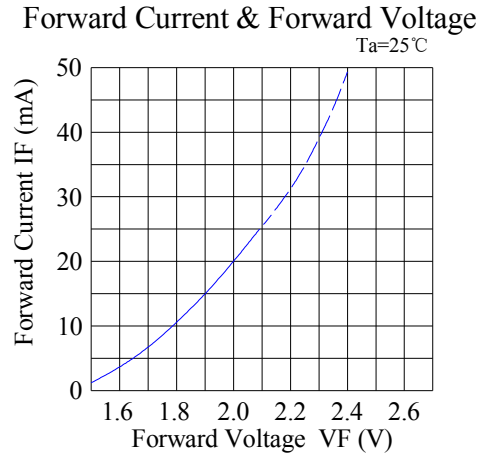
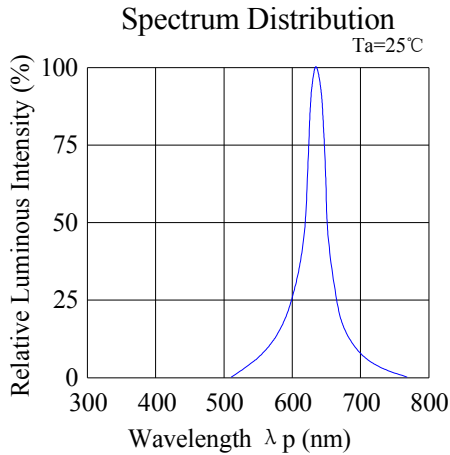



### Typical electrical/optical characteristic curves:

(25°C Ambient Temperature Unless Otherwise Noted)

