



Part No.: JSL-322URPGW

Features:

- Long life solid state reliability.
- Low power consumption
- I.C.compatible.
- Compliance with EU REACH.
- RoHs Compliant

Descriptions:

- Emitting Color: Red+Pure Green Bi-Color.
- Device Outline: ϕ 3mm Round Type.
- Lens Type: White Diffused.
- The lamp contain two chips and is available as both bicolor and bipolar types.
- The designed for avariety of applications where require dual illumination.

Application:

- Circuit board.
- Indicators.
- Computer.
- Home appliance.
- Industrial.



Part No.: JSL-322URPGW

Package Dimension:

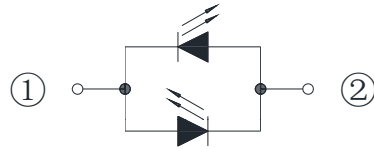
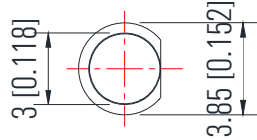

1 Anode the First Color,
Cathode the Second Color
2 Anode the Second Color,
Cathode the First Color

Polarity

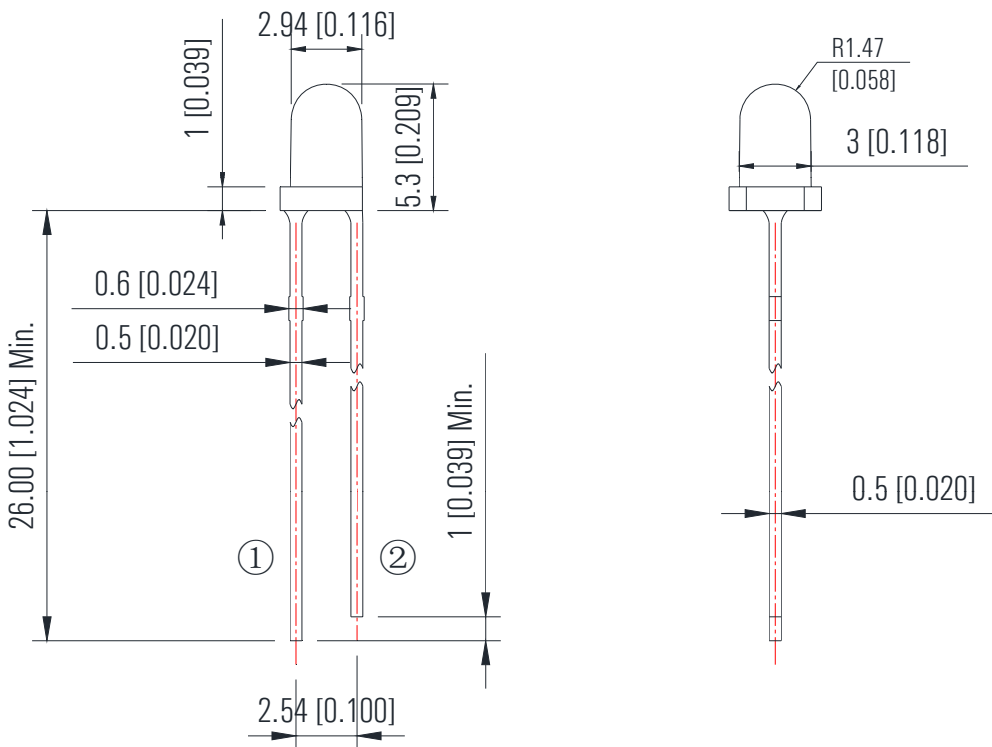

Notes:

1. All dimensions are millimeters/单位: mm.
2. Tolerance is +/-0.25mm unless otherwise noted/
没有标注的公差均为±0.25mm



Absolute maximum ratings (Ta = 25°C)

Parameter	Symbol	Test Condition	Values		Unit
			Min.	Max.	
Reverse Voltage	V _R	I _R = 30 μ A	----	5	V
Forward Current	I _F	----	----	25	mA
Power Dissipation	P _d	----	Red	60	mW
			Pure Green	85	
Pulse Current	I _{peak}	Duty=0.1mS, 1kHz	----	100	mA
Operating Temperature	T _{opr}	----	-40	+85	°C
Storage Temperature	T _{str}	----	-40	+85	°C

Electrical and optical characteristics (Ta = 25°C)

Parameter	Symbol	Test Condition	Color	Value			Unit
				Min.	Typ.	Max.	
Forward Voltage	V _F	I _F = 20mA	UR	1.8	2.0	2.2	V
			PG	2.7	3.0	3.2	
Reverse Current	I _R	V _R = 5V	UR	---	---	5	μ A
			PG	---	---	5	
Dominate Wavelength	λ _d	I _F = 20mA	UR	---	624	---	nm
			PG	---	525	---	
Peak Wavelength	λ _p	I _F = 20mA	UR	---	632	---	nm
			PG	---	520	---	
Spectral Line half-width	Δ λ	I _F =20mA	UR	----	20	----	nm
			PG				
Luminous Intensity	I _v	I _F = 20mA	UR	300	500	----	mcd
			PG	1500	2000	----	
Viewing Angle	2 θ 1/2	I _F = 20mA	UR	---	60	---	deg
			PG				



Typical electrical/optical characteristic curves:

(25°C Ambient Temperature Unless Otherwise Noted)

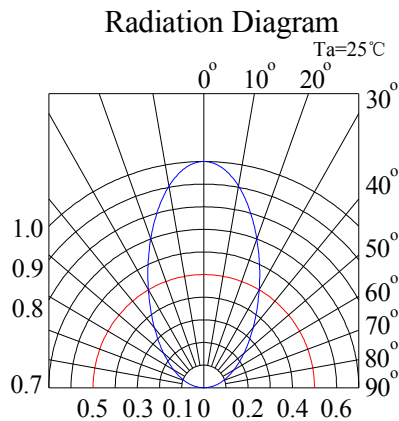
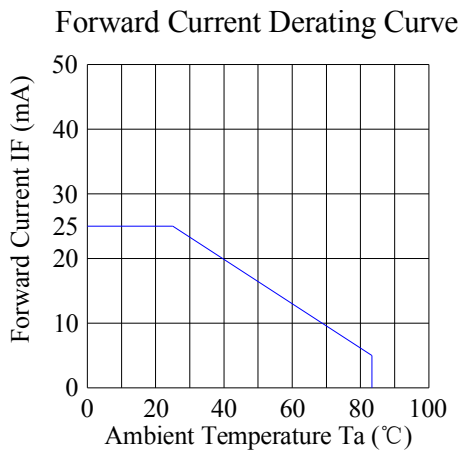
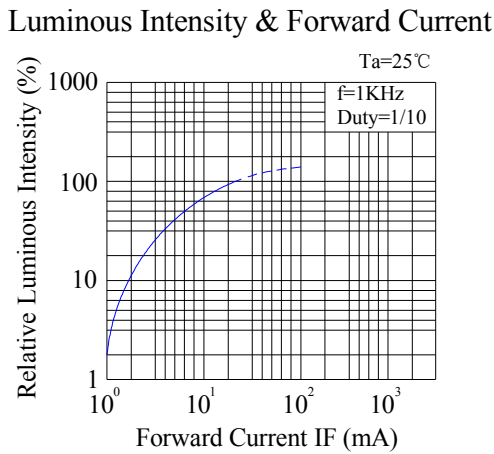
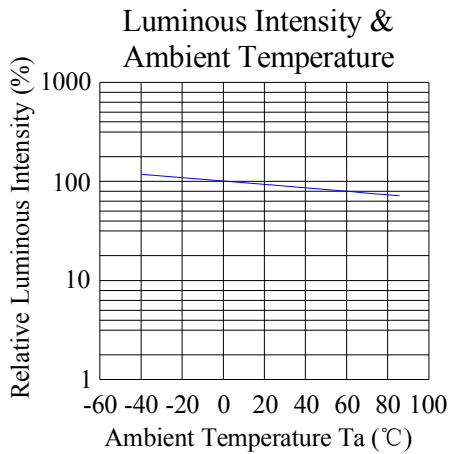
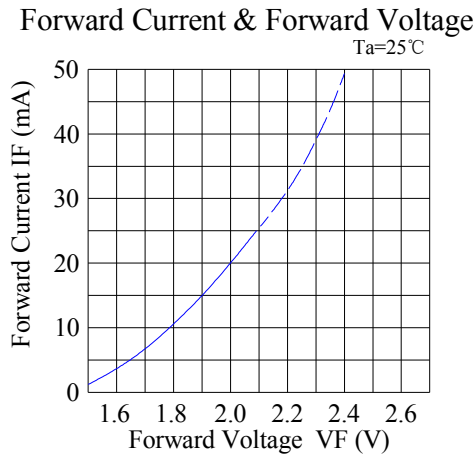
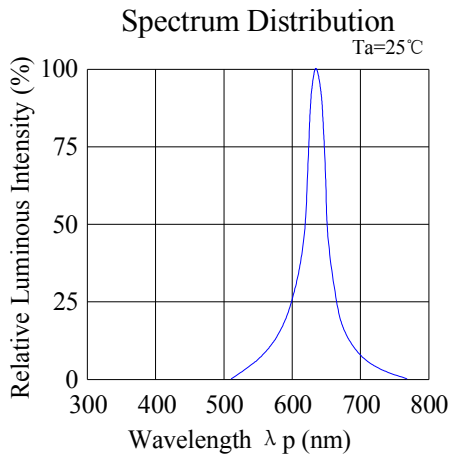

Typical electrical/optical characteristic curves:

(25°C Ambient Temperature Unless Otherwise Noted)

