



Part No.: JSL-531RGBW-CA

Features:

- Long life solid state reliability.
- Low power consumption
- I.C.compatible.
- Compliance with EU REACH.
- RoHs Compliant

Descriptions:

- Emitting Color: Super Bright RGB.
- Device Outline: ϕ 5mm Round Type.
- Lens Type: White Diffused.
- Four Leads With One Common Anode Type.

Application:

- Circuit board.
- TV set.
- Computer.
- Home appliance.
- Industrial.



Part No.: JSL-531RGBW-CA

Package Dimension:

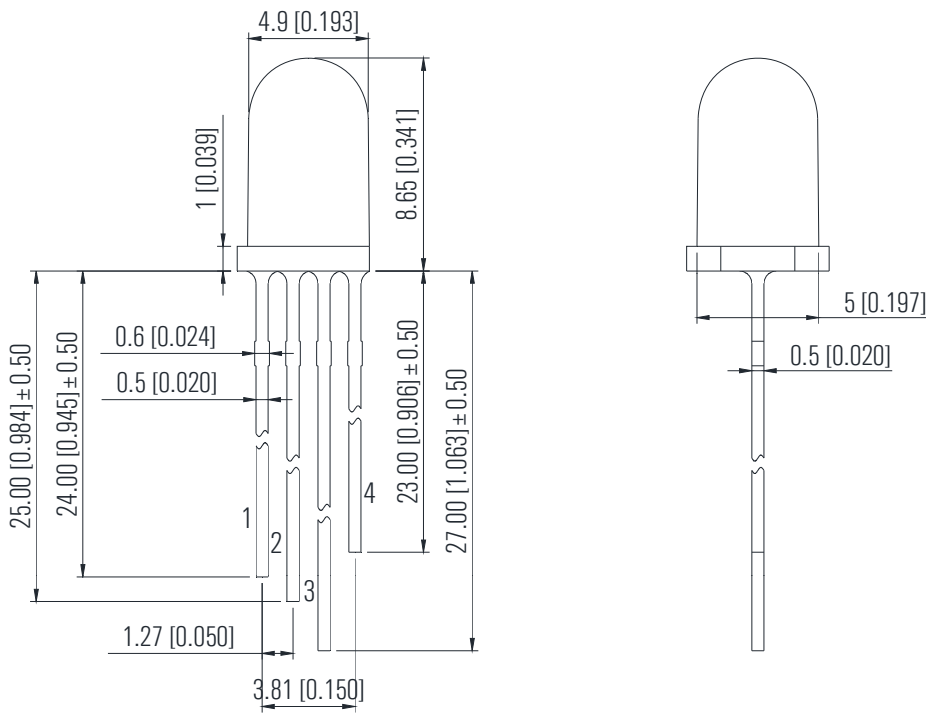
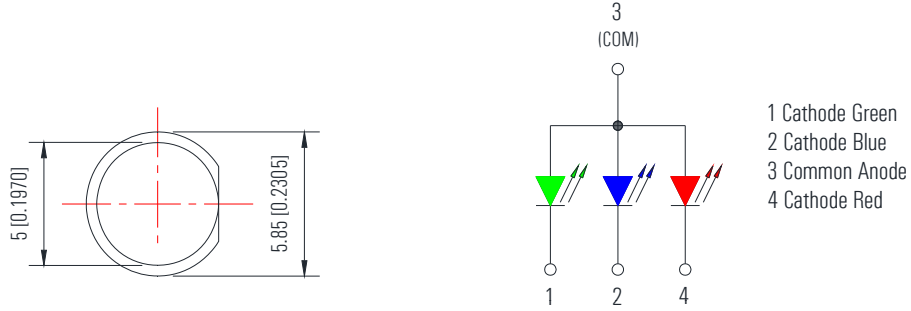

Notes:

1. All dimensions are millimeters/单位: mm.
2. Tolerance is +/-0.25mm unless otherwise noted/
没有标注的公差均为±0.25mm



Part No.: JSL-531RGBW-CA

Absolute maximum ratings (Ta = 25°C)

Parameter	Symbol	Test Condition	Values		Unit
			Min.	Max.	
Reverse Voltage	V _R	I _R = 30 μA	----	5	V
Forward Current	I _F	----	----	25	mA
Power Dissipation	Red	P _d	----	60	mW
	Green			90	
	Blue			90	
Pulse Current	I _{peak}	Duty=0.1mS, 1kHz	----	100	mA
Operating Temperature	T _{opr}	----	-40	+85	°C
Storage Temperature	T _{str}	----	-40	+85	°C

Electrical and optical characteristics (Ta = 25°C)

Parameter	Symbol	Test Condition	Color	Value			Unit
				Min.	Typ.	Max.	
Forward Voltage	V _F	I _F = 20mA	Red	1.8	2.0	2.4	V
			Green	2.6	3.0	3.4	
			Blue	2.6	3.0	3.4	
Reverse Current	I _R	V _R = 5V		---	---	5	μA
Dominate Wavelength	λ _d	I _F = 20mA	Red	---	624	---	nm
			Green	---	525	---	
			Blue	---	470	---	
Peak Wavelength	λ _p	I _F = 20mA	Red	---	632	---	nm
			Green	---	520	---	
			Blue	---	468	---	
Spectral Line half-width	Δλ	I _F =20mA		---	20	---	nm
Luminous Intensity	I _v	I _F = 20mA	Red	900	1200	---	mcd
			Green	2000	4000	---	
			Blue	800	1000	---	
Viewing Angle	2θ 1/2	I _F = 20mA		---	60	---	deg



Part No.: JSL-531RGBW-CA

Typical electrical/optical characteristic curves:

(25°C Ambient Temperature Unless Otherwise Noted)

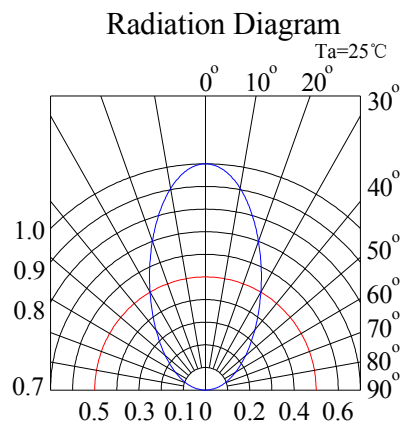
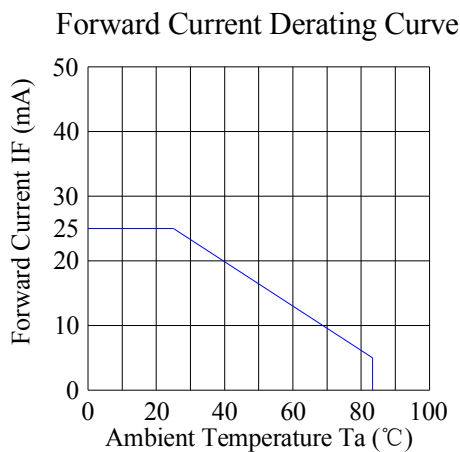
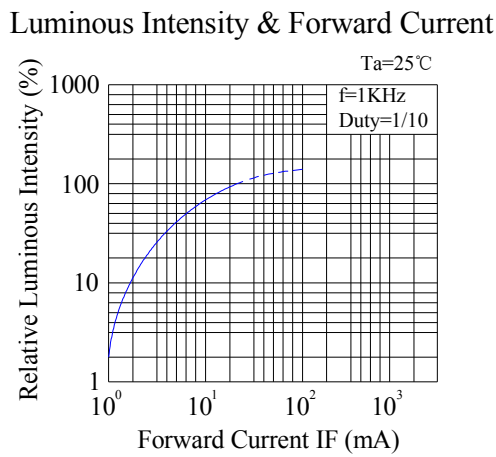
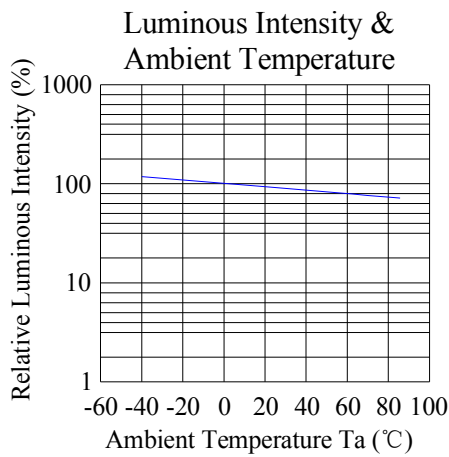
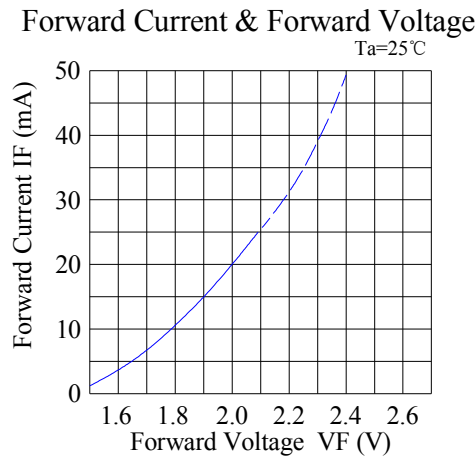
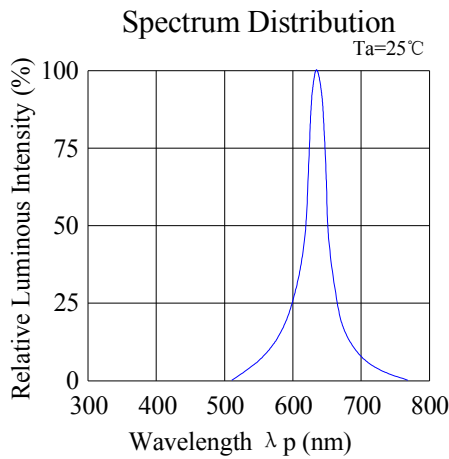

Part No.: JSL-531RGBW-CA

Typical electrical/optical characteristic curves:

(25°C Ambient Temperature Unless Otherwise Noted)

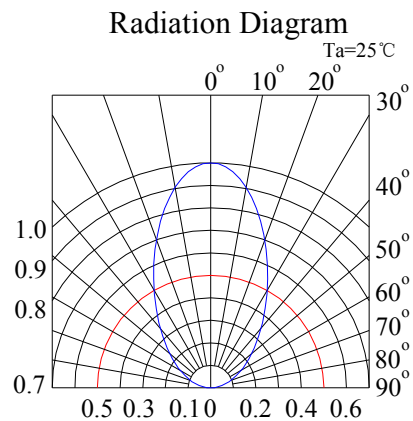
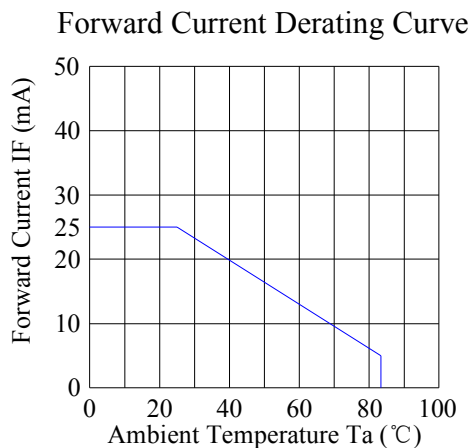
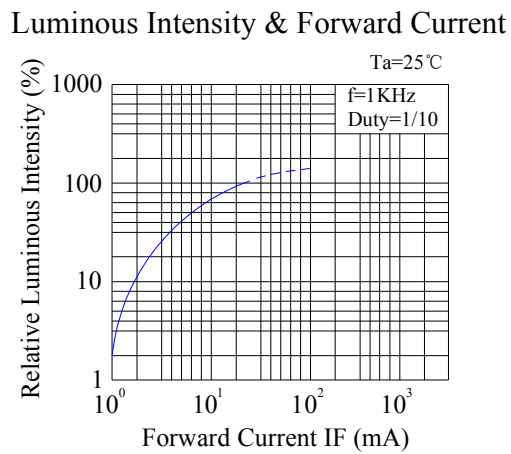
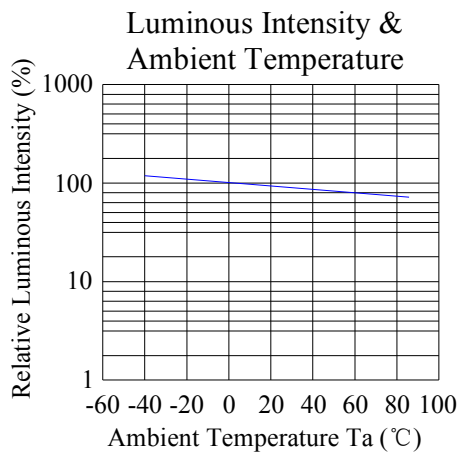
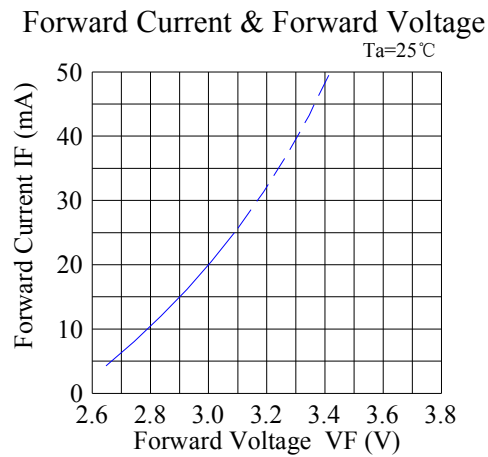
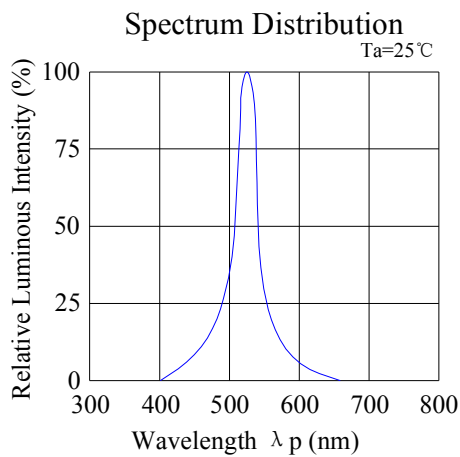

Part No.: JSL-531RGBW-CA

Typical electrical/optical characteristic curves:

(25°C Ambient Temperature Unless Otherwise Noted)

