



**Part No.: JSL-531RGBC-CC**

## **Features:**

- Long life solid state reliability.
- Low power consumption
- I.C.compatible.
- Compliance with EU REACH.
- RoHs Compliant

## **Descriptions:**

- Emitting Color: Super Bright RGB.
- Device Outline:  $\phi$  5mm Round Type.
- Lens Type: Water Clear.
- Four Leads With One Common Cathode Type.

## **Application:**

- Circuit board.
- TV set.
- Computer.
- Home appliance.
- Industrial.



Part No.: JSL-531RGBC-CC

Package Dimension:

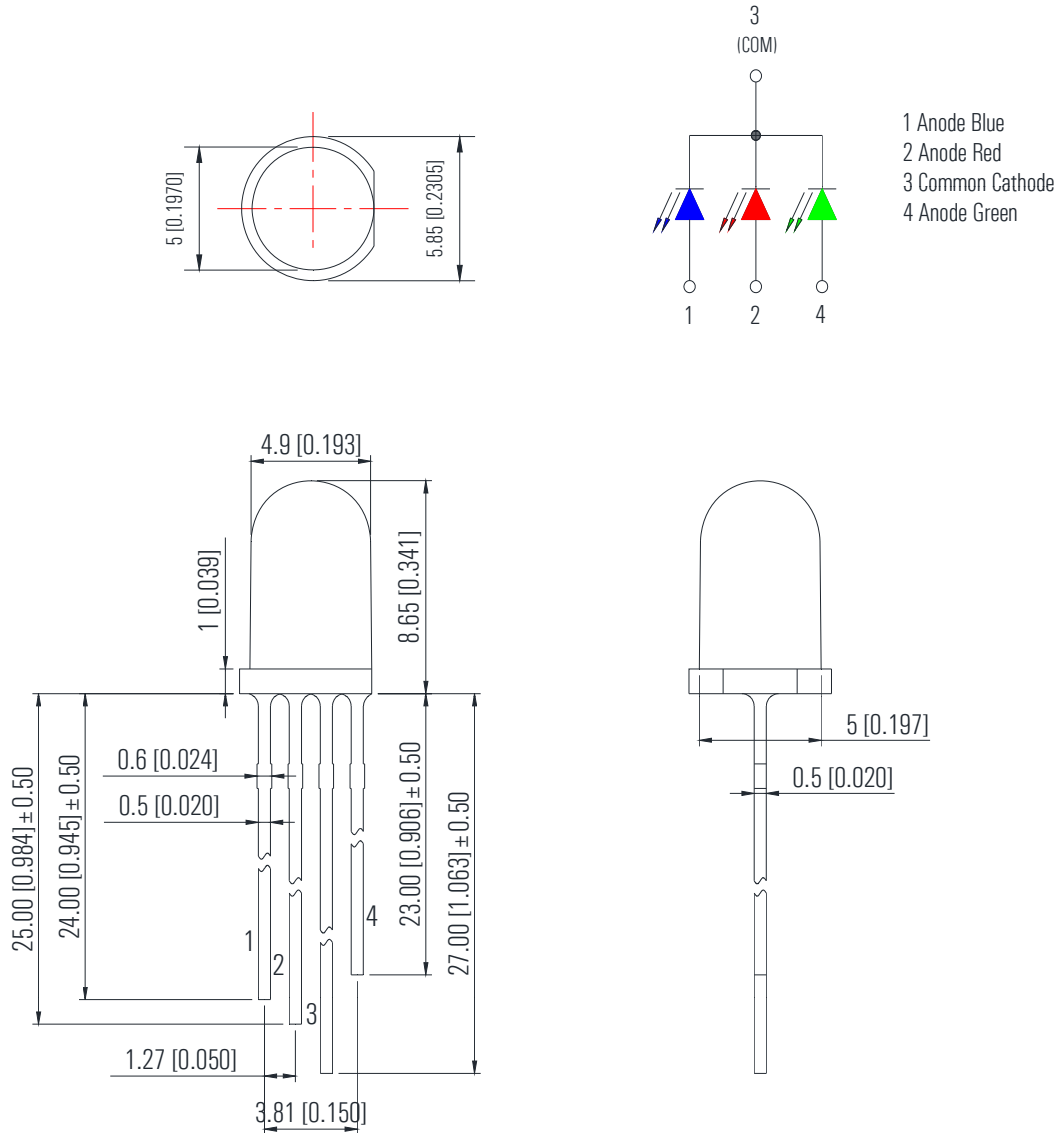

Notes:

1. All dimensions are millimeters/单位: mm.
2. Tolerance is +/-0.25mm unless otherwise noted/  
没有标注的公差均为±0.25mm



Part No.: JSL-531RGBC-CC

**Absolute maximum ratings (Ta = 25°C)**

Parameter	Symbol	Test Condition	Values		Unit
			Min.	Max.	
Reverse Voltage	V <sub>R</sub>	I <sub>R</sub> = 30 μA	----	5	V
Forward Current	I <sub>F</sub>	----	----	25	mA
Power Dissipation	Red	P <sub>d</sub>	----	60	mW
	Green			90	
	Blue			90	
Pulse Current	I <sub>peak</sub>	Duty=0.1mS, 1kHz	----	100	mA
Operating Temperature	T <sub>opr</sub>	----	-40	+85	°C
Storage Temperature	T <sub>str</sub>	----	-40	+85	°C

**Electrical and optical characteristics (Ta = 25°C)**

Parameter	Symbol	Test Condition	Color	Value			Unit
				Min.	Typ.	Max.	
Forward Voltage	V <sub>F</sub>	I <sub>F</sub> = 20mA	Red	1.8	2.0	2.4	V
			Green	2.6	3.0	3.4	
			Blue	2.6	3.0	3.4	
Reverse Current	I <sub>R</sub>	V <sub>R</sub> = 5V		---	---	5	μA
Dominate Wavelength	λ <sub>d</sub>	I <sub>F</sub> = 20mA	Red	---	624	---	nm
			Green	---	525	---	
			Blue	---	470	---	
Peak Wavelength	λ <sub>p</sub>	I <sub>F</sub> = 20mA	Red	---	632	---	nm
			Green	---	520	---	
			Blue	---	468	---	
Spectral Line half-width	Δλ	I <sub>F</sub> =20mA		---	20	---	nm
Luminous Intensity	I <sub>v</sub>	I <sub>F</sub> = 20mA	Red	2000	2500	---	mcd
			Green	4000	6000	---	
			Blue	1500	2000	---	
Viewing Angle	2θ 1/2	I <sub>F</sub> = 20mA		---	30	---	deg



## Part No.: JSL-531RGBC-CC

### Typical electrical/optical characteristic curves:

(25°C Ambient Temperature Unless Otherwise Noted)

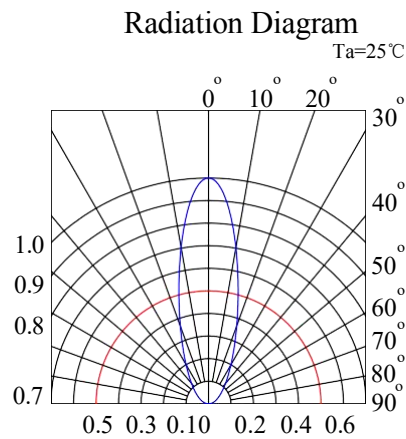
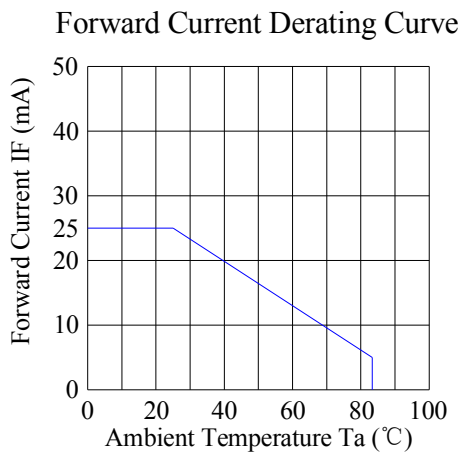
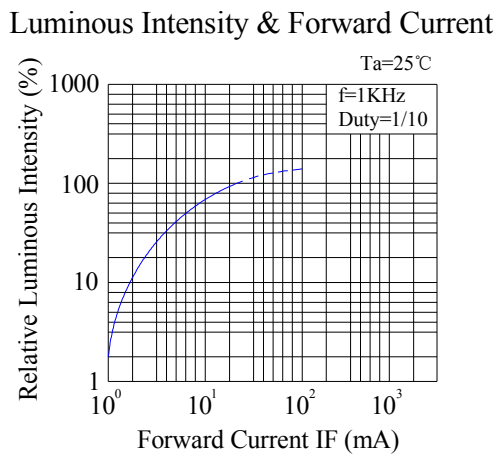
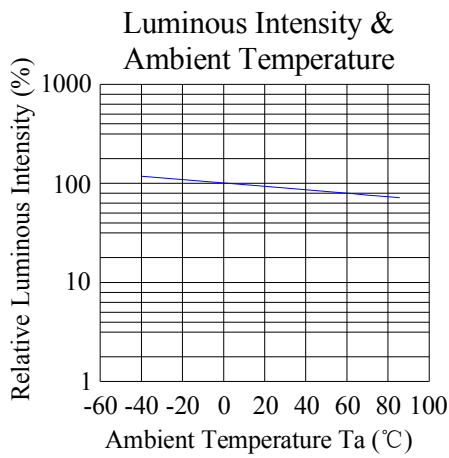
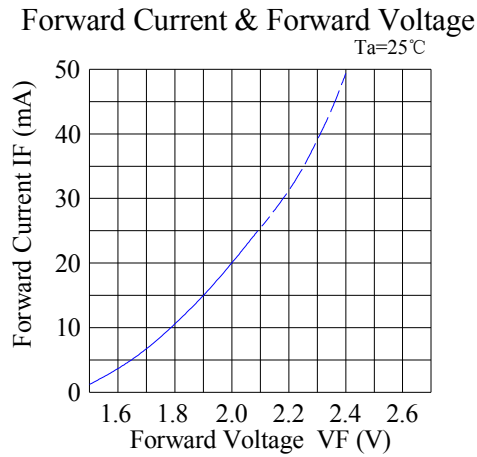
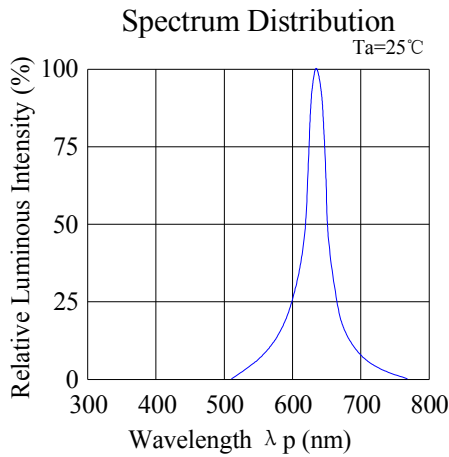



Part No.: JSL-531RGBC-CC

Typical electrical/optical characteristic curves:

(25°C Ambient Temperature Unless Otherwise Noted)

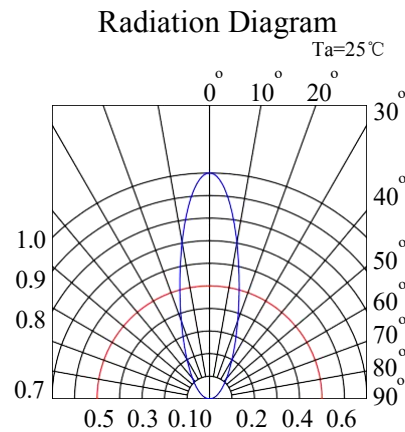
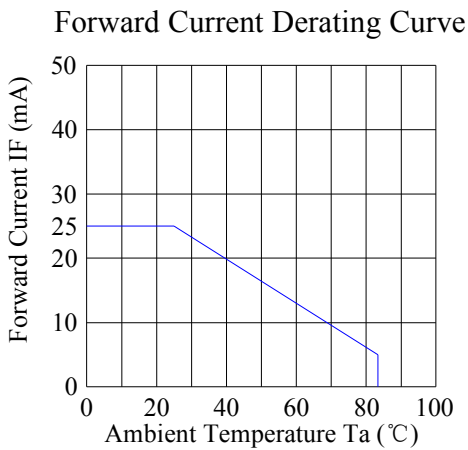
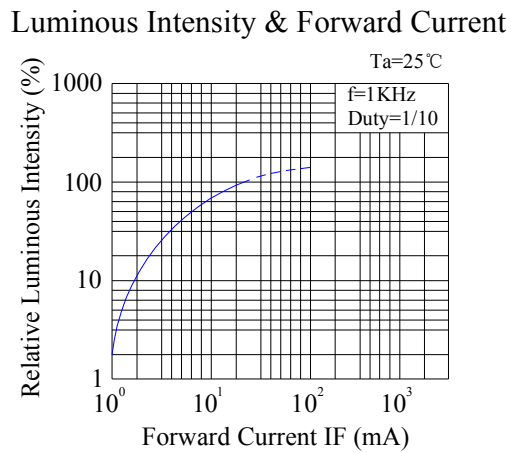
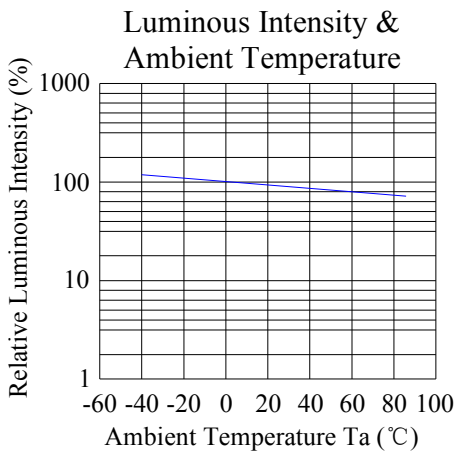
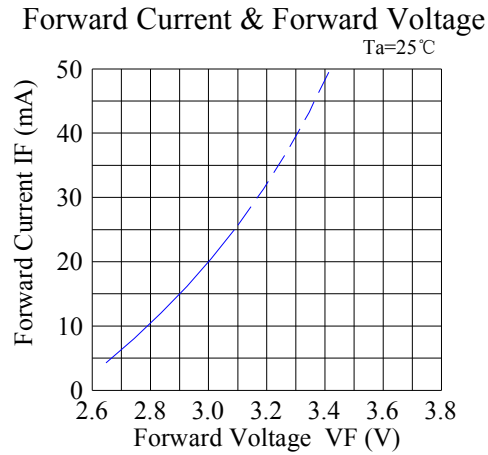
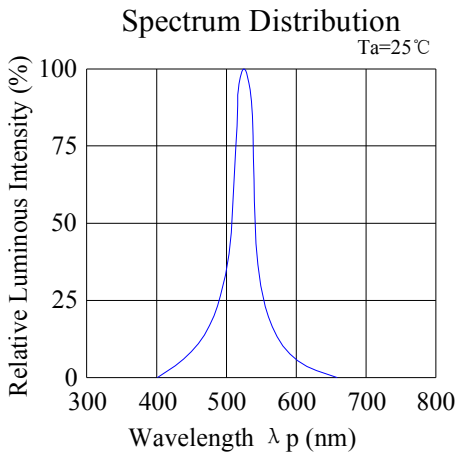

## Part No.: JSL-531RGBC-CC

### Typical electrical/optical characteristic curves:

(25°C Ambient Temperature Unless Otherwise Noted)

