



**Part No.: JSL-0602UAC**

**Features:**

- Single color
- High bright output
- Low power consumption
- High reliability and long life
- The product itself will remain within RoHS compliant version

**Descriptions:**

- Emitting Color: Super Bright Orange
- Device Outline: 1.7x0.6x1.1mm
- Lens Type: Water Clear
- The LED lamps are available with different colors, intensities.

**Application:**

- Circuit board.
- Indicators.
- Backlighting.
- General use.



Part No.: JSL-0602UAC

Package Dimension:

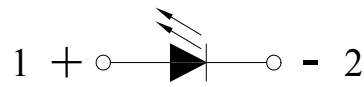
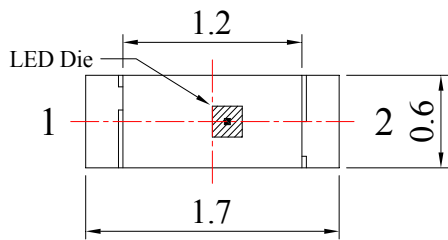

Polarity

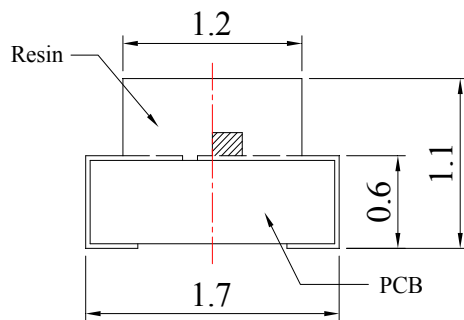

Recommended Soldering Pad Dimensions

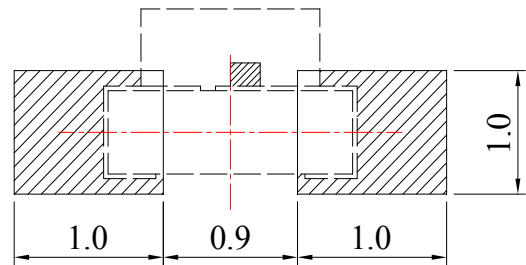
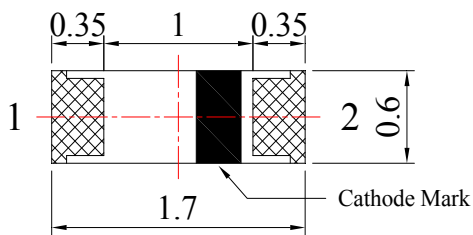

Unit: mm  
Tolerance:  $\pm 0.10\text{mm}$

Notes:

1. All dimensions are millimeters/单位: mm.
2. Tolerance is  $\pm 0.25\text{mm}$  unless otherwise noted/  
没有标注的公差均为 $\pm 0.25\text{mm}$



Part No.: JSL-0602UAC

**Absolute maximum ratings (Ta = 25°C)**

Parameter	Symbol	Test Condition	Values		Unit
			Min.	Max.	
Reverse Voltage	V <sub>R</sub>	I <sub>R</sub> = 30 μ A	----	5	V
Forward Current	I <sub>F</sub>	----	----	25	mA
Power Dissipation	P <sub>d</sub>	----	----	60	mW
Pulse Current	I <sub>peak</sub>	Duty=0.1mS, 1kHz	----	100	mA
Operating Temperature	T <sub>opr</sub>	----	-40	+85	°C
Storage Temperature	T <sub>str</sub>	----	-40	+85	°C

**Electrical and optical characteristics (Ta = 25°C)**

Parameter	Symbol	Test Condition	Values			Unit
			Min.	Typ.	Max.	
Forward Voltage	V <sub>F</sub>	I <sub>F</sub> =20mA	1.8	2.0	2.4	V
Reverse Current	I <sub>R</sub>	V <sub>R</sub> =5V	----	----	30	μ A
Dominate Wavelength	λ <sub>d</sub>	I <sub>F</sub> =20mA	----	605	----	nm
Peak Wavelength	λ <sub>p</sub>	I <sub>F</sub> =20mA	----	610	----	nm
Spectral Line half-width	Δ λ	I <sub>F</sub> =20mA	----	20	----	nm
Luminous Intensity	I <sub>v</sub>	I <sub>F</sub> =20mA	80	150	----	mcd
Viewing Angle	2 θ 1/2	I <sub>F</sub> =20mA	----	120	----	deg.



## Part No.: JSL-0602UAC

### Typical electrical/optical characteristic curves:

(25°C Ambient Temperature Unless Otherwise Noted)

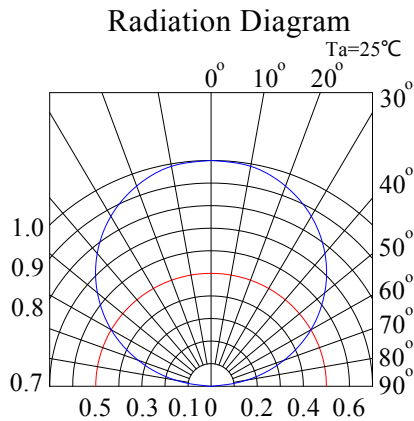
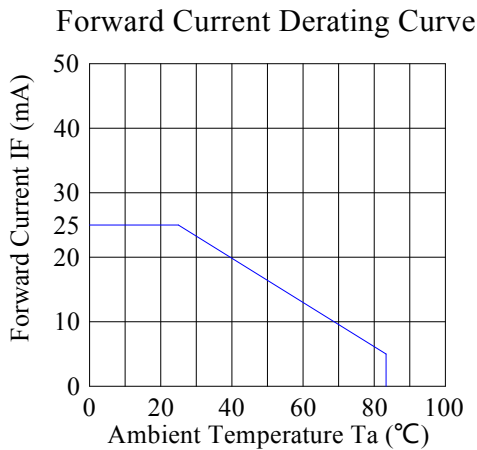
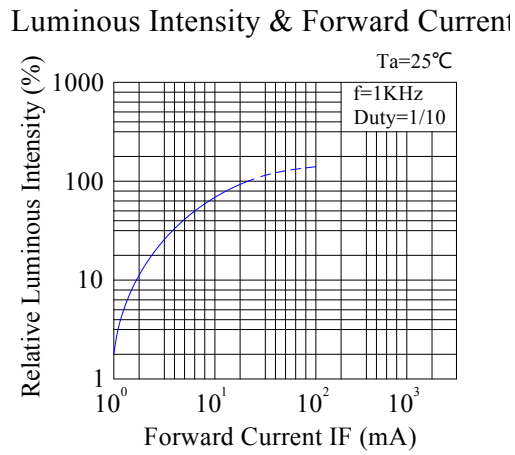
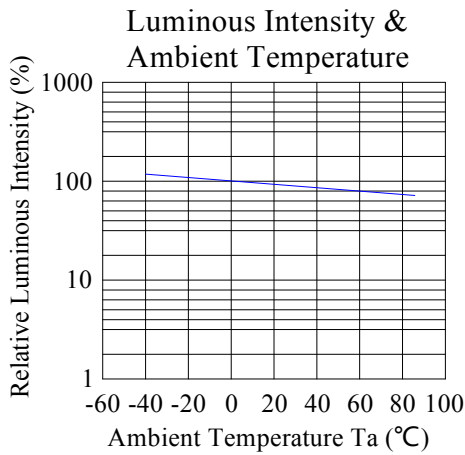
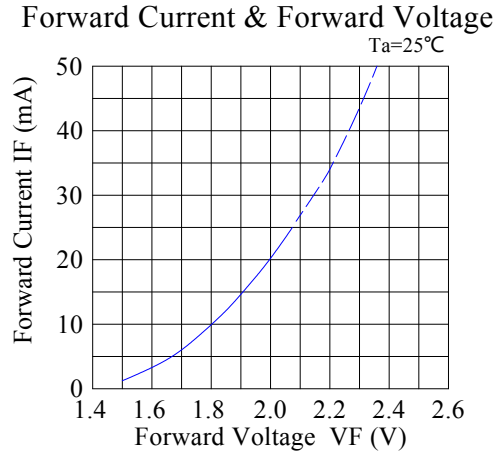
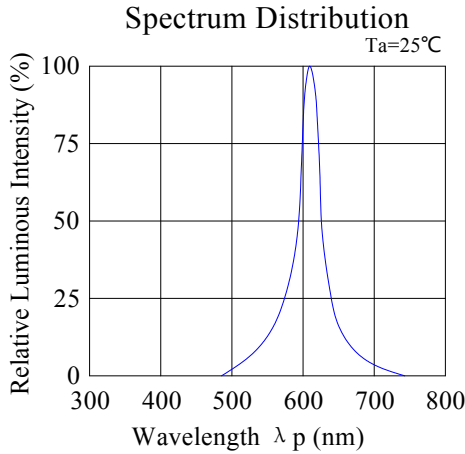





Part No.: **JSL-0602UAC**

**Packaging:**

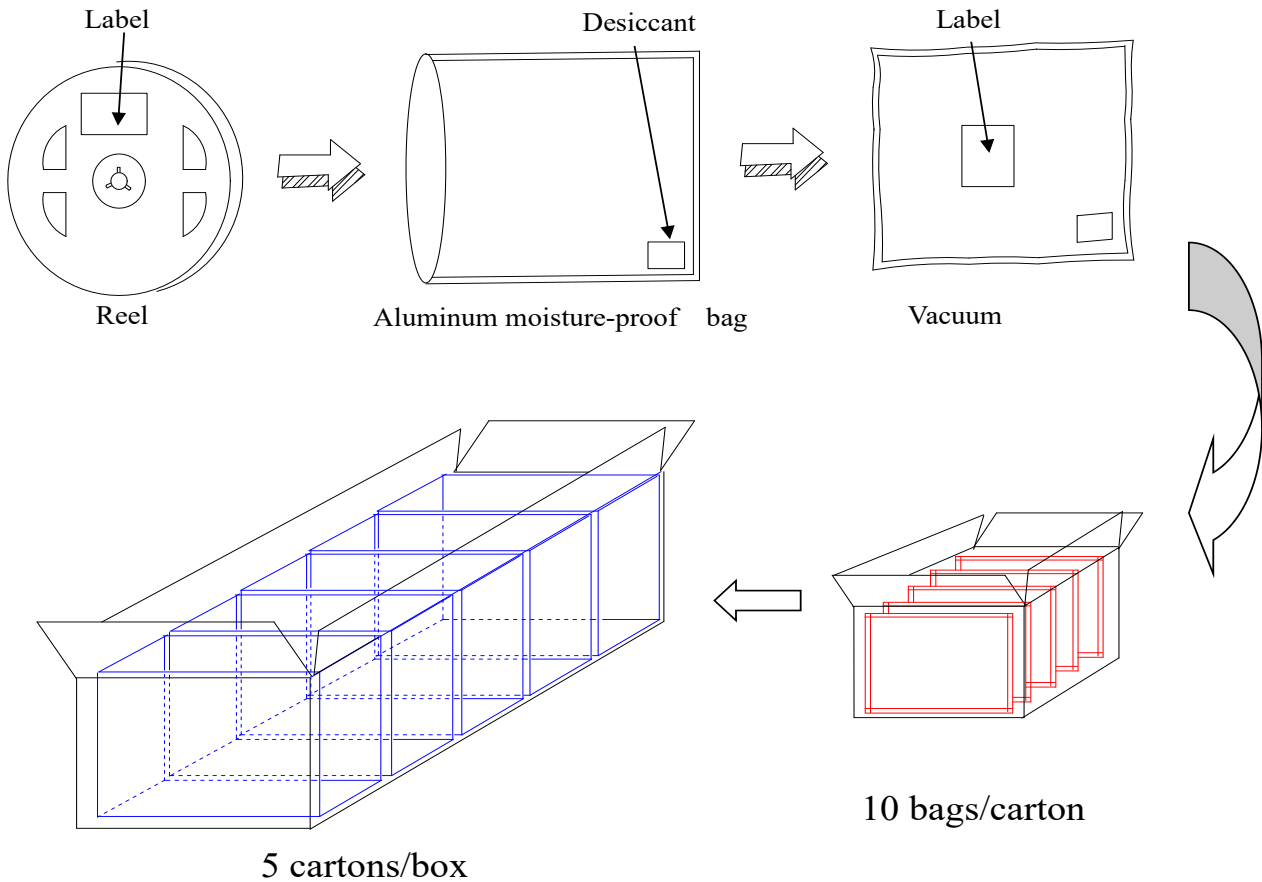
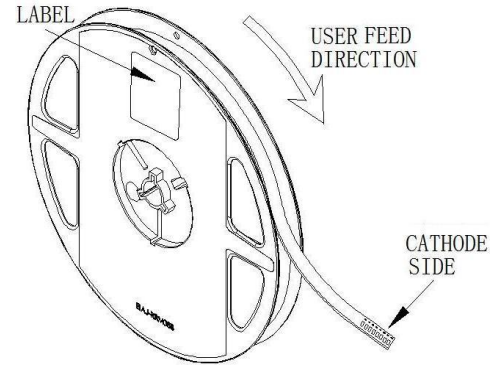
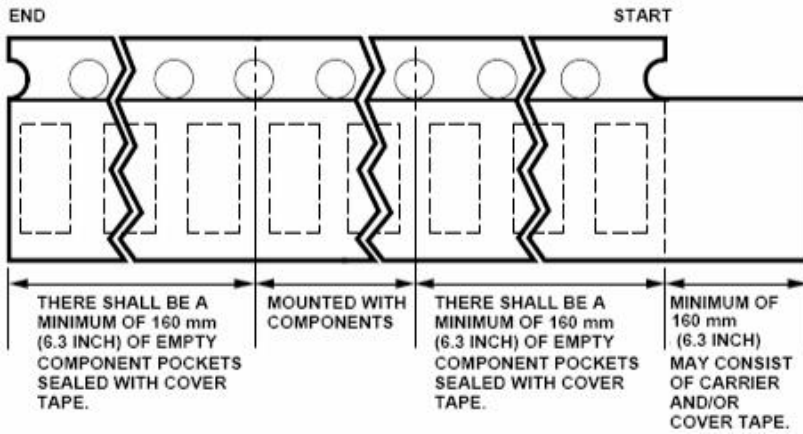



### Soldering Profile Suggested:

1. Pb-free solder temperature profile

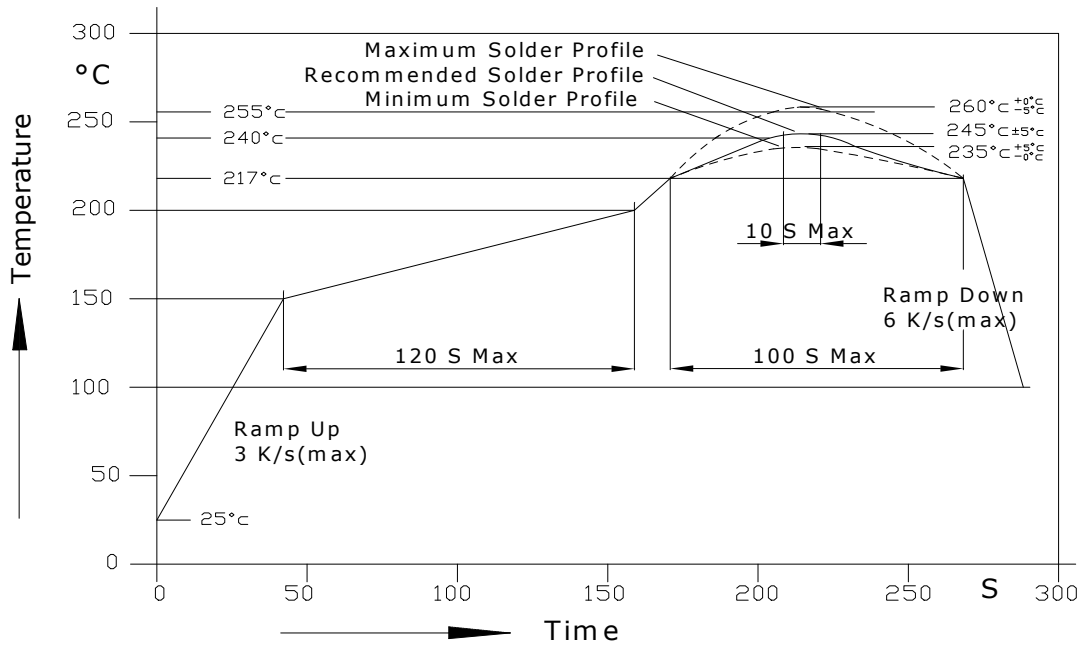

2. Reflow soldering should not be done more than two times.
3. When soldering, do not put stress on the LEDs during heating.
4. After soldering, do not warp the circuit board.
5. Recommended soldering conditions:

Reflow soldering		Soldering iron	
Pre-heat	150~200°C	Temperature	300°C Max.
Pre-heat time	120 sec. Max.	Soldering time	3 sec. Max.
Peak temperature	260°C Max.		(one time only)
Soldering time	10 sec. Max.(Max. two times)		



### Cautions:

#### Application

1. A LED is a current-operated device. The slight shift of voltage will cause big change of current, which will damage LEDs. Customer should use resistors in series for the Over-Current-Proof.
2. In order to ensure intensity uniformity on multiple LEDs connected in parallel in an application, it is recommended to use individual resistor separately, as shown in Circuit A below. The brightness of each LED shown in Circuit B might appear difference due to the differences in the I-V characteristics of those LEDs.

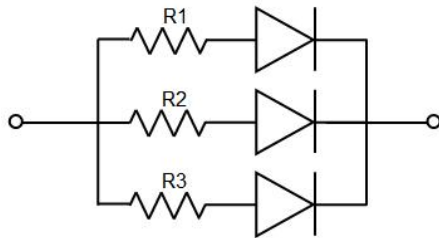

**Circuit model A**

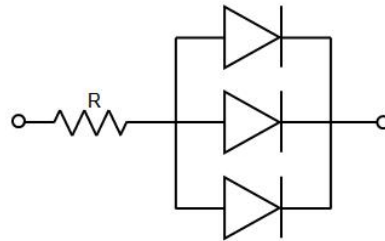

**Circuit model B**

3. High temperature may reduce LEDs' intensity and other performances, so keeping it away from heat source to get good performance is necessary.

#### Storage

1. Before opening original package, it is recommended to store them in the following environment:  
Temperature: 5°C~30°C                      Humidity: 85%RH max.
2. After opening original package, the storage ambient for the LEDs should be in 5~30°C temperature and 60% or less relative humidity.
3. In order to avoid moisture absorption, it is recommended that the LEDs that out of the original package should be stored in a sealed container with appropriate desiccant, or in desiccators with nitrogen ambient.
4. The LEDs should be used within 168hrs (7 days) after opening the package. Once been mounted, soldering should be quick.
5. If the moisture absorbent material (silica gel) has faded away or the LEDs stored out of original package for more than 168hrs (7 days), baking treatment should be performed using the conditions: 60°C at least 24 hours.



---

## Part No.: JSL-0602UAC

### ESD (Electrostatic Discharge )-Protection

A LED (especially the Blue、 White and Green product) is an ESD sensitive component, and static electricity or power surge will damage the LED. ESD-damaged LEDs will exhibit abnormal characteristics such as high reverse leakage current, low forward voltage, or “no light-up” at low currents, etc.

Some advice as below should be noticed:

1. A conductive wrist strap or anti-electrostatic glove should be worn when handling these LEDs.
2. All devices, equipment, machinery, work tables and storage racks, etc. must be properly grounded.
3. Use anti-static package or boxes to carry and storage LEDs. And ordinary plastic package or boxes is forbidden to use.
4. Use ionizer to neutralize the static charge during handling or operating.
5. All surfaces and objects within 1 ft close to LEDs measure less than 100V.

### Cleaning

Use alcohol-based cleaning solvents such as IPA (isopropyl alcohol) to clean LEDs if necessary.

### Soldering

1. Soldering condition refer to the draft “Soldering Profile Suggested” on page 1.
2. Reflow soldering should not be done more than 2 times.
3. Manual soldering is only suggested on repair and rework. The maximum soldering temperature should not exceed 300°C within 3 sec. And the maximum capacity of soldering iron is 30W in power.
4. During the soldering process, do not touch the lens at high temperature.
5. After soldering, any mechanical force on the lens or any excessive vibration shall not be accepted to apply, also the circuit board shall not be bent as well.

### Others

1. The LEDs described here are intended to be used for ordinary electronic equipment (such as office equipment, communication equipment and household applications).Consult CMH’s Sales in advance for the applications in which exceptional reliability is required, particularly when the failure or malfunction of the LEDs may directly jeopardize life or health. (such as in aviation, transportation, traffic control equipment, medical and life support systems and safety devices).
2. The light output from the high luminous intensity LEDs may cause injury to human eyes when viewed directly.
3. The appearance and specifications of the product may be modified for improvement without prior notice.